

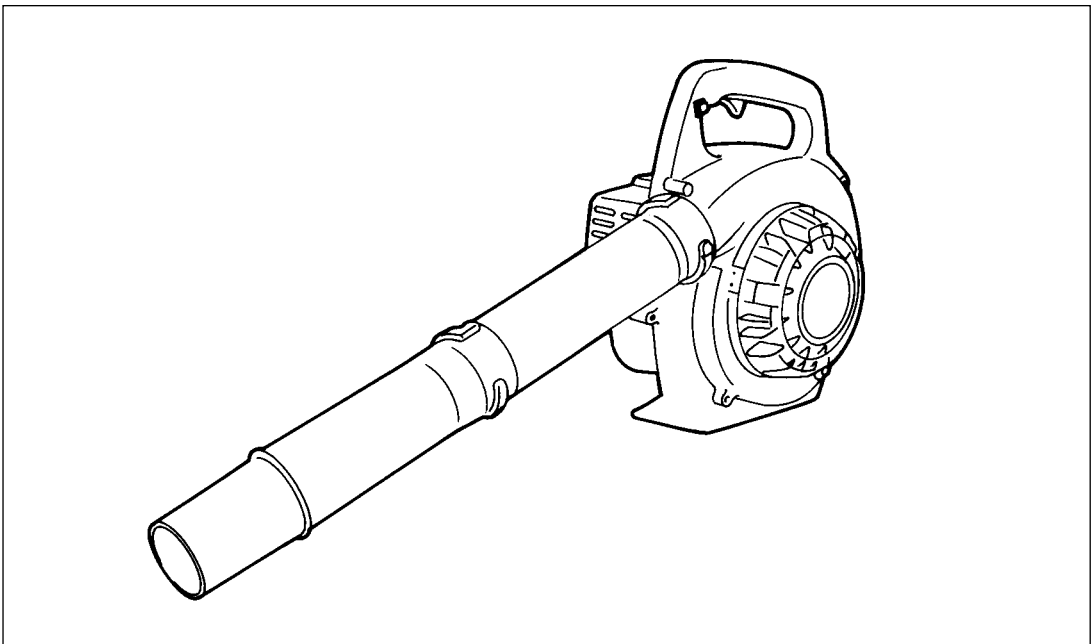

OWNER/OPERATOR MANUAL

HANDHELD BLOWER

HBZ2500



WARNING



The engine exhaust from this product contains chemicals known to the State of California to cause cancer, birth defects or other reproductive harm.

Thank you for purchasing a RedMax product.

Before using our blower, please read this manual carefully to understand the proper use of your unit.

APPLICABLE SERIAL NUMBERS :

DRIVE UNIT 100101 and up

ENGINE UNIT 100101 and up



Read this manual carefully to understand all safety precautions, controls, proper operation and maintenance of your RedMax blower. Failure to do so could result in serious injury.



SAFETY FIRST

Instructions contained in warnings within this manual and warning seals marked with a  symbol on the blower concern critical points which must be taken into consideration to prevent possible serious bodily injury, and for this reason you are requested to read all such instructions carefully and follow them without fail.

Note that there may be times when warning seals peel off or become soiled and impossible to read. If this happens, you should contact the dealer from which you purchased the product to order new seals and affix the new seal(s) in the required location(s).

■ Notes on types of warnings



Instructions labeled as shown at left concern critical steps or procedures which must be followed in order to prevent accidents which could lead to serious bodily injury or death. This mark is used to indicate instructions which must be followed without exception.



Instructions labeled as shown at left concern steps or procedures which, if not followed correctly, could lead to mechanical failure, breakdown, or damage.



Used to label supplementary instructions designed to provide hints or directions useful in the use of the product.

CONTENTS

SAFETY PRECAUTIONS	4
OPERATOR	
USE OF BLOWER	
WORKING CONDITION	
AVOID NOISE PROBLEM	
AVOID CHANCES OF DAMAGE	
SYMBOLS ON THE MACHINE	7
PARTS LOCATION & SPECIFICATIONS	8
ASSEMBLY	8
BLOWER PIPE	
FUEL	9
HOW TO MIX FUEL	
FUELING THE UNIT	
OPERATION	10
STARTING ENGINE	
RESTARTING ENGINE WHILE ENGINE HOT	
STOPPING ENGINE	
ADJUSTING IDLE SPEED	
MAINTENANCE	11
AIR CLEANER	
FUEL FILTER	
SPARK PLUG	
MUFFLER	
SPARK ARRESTER	
AIR INLET SCREEN	
HOW TO INSTALL THE AIR INLET SCREEN TO THE VOLUTE COVER	
STORAGE	13
TROUBLESHOOTING GUIDE	14
PARTS LIST	15



Safety Precautions

- Read this Blower Owner/Operator Manual carefully. Be sure you understand how to operate this unit properly before you use it. Failure to do so could result in serious injury.



- Be sure to keep this manual handy so that you may refer to it later whenever any questions arise. Also note that you are requested to contact the dealer from whom you purchased the product for assistance the event that you have any questions which cannot be answered herein.
- Always be sure to include this manual when selling, lending, or otherwise transferring the ownership of this product.

- Wear rubber-soled shoes or shoes with some other form of anti-slip protection to help protect you against falling.
- Be sure to wear proper work clothing.

■ USE OF BLOWER

- Each time before starting the engine, inspect the entire unit to see if every part is in good order and is securely tightened in place. If any damage is found in the fuel line, the exhaust line, or the ignition wiring, do not use the blower until it has been repaired.

■ OPERATOR

- Refrain from operating the blower if you are tired, ill, or upset, or if you are under the influence of alcohol, drugs or medication.



- Always wear eye protection goggles.
- Always wear ear protectors to protect your ears from engine noise. If this guideline is not followed, hearing loss can occur.



- Wear a face mask to guard against the inhalation of dust.



Safety Precautions

⚠ WARNING

- **Never use the blower without the screen at the air intake of the blower. Before each use, check that the screen is attached in place and is free from any damage.**

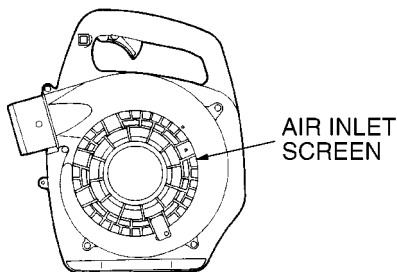

⚠ WARNING

- **Never remove debris from the intake screen while the engine is running. Contact with rotating blower fan may**

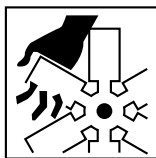

result in a serious personal injury.

- Do not allow children to use blower. Make sure that each person you authorize to operate the blower understands all of the safety rules in this manual.
- Avoid using any accessory or attachment other than those bearing the RedMax mark for use with the blower.
- When suspending a job or inspecting the blower, be sure to stop engine.
- Drain the fuel from the fuel tank before transporting or storing the blower.
- When storing the blower, choose a space indoors free from moisture and out of the reach of children.
- Examine the blower at intervals for loose fasteners and rusted or damaged parts. Use special care **around the fuel line, the muffler, and the ignition wiring.**

- All engine service except for those described in this manual should be performed by competent service personnel. Improper service to the blower fan and muffler could cause a hazardous failure.

■ WORKING CONDITION

⚠ WARNING

- Keep open flames and sparks away from the area where fuel is handled or stored, as the fuel is highly flammable.



- Make sure that the engine has cooled down before refueling.
- Mix and store fuel only in a approved container.
- Never smoke while refueling the blower.
- Wipe off any spilled fuel and tighten the fuel cap securely.
- Move at least 3m(10 ft) away from the fueling spot before starting the engine.
- Check the work area that the blower will be used in and remove or cover all valuables that may be damaged by the air blast or thrown debris.
- Avoid running the engine indoors. The exhaust gases contain harmful carbon monoxide.

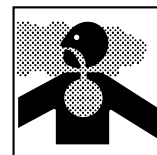



Safety Precautions

- Keep operation area clear of all persons, particularly small children and pets. Injury may result from flying debris.
- Avoid using the blower where stable footing and balance are not assured.
- Never touch the spark plug or plug cord while the engine is in operation. Doing so may result in being subjected to an electrical shock.



- Never touch the muffler, spark plug, or other metallic parts of the engine while the engine is in operation or immediately after shutting down the engine. These metallic parts reach high temperatures during operation and doing so could result in serious burns.



■ AVOID NOISE PROBLEM

NOTE

Check and follow the local regulations as to sound level and hours of operations for blower.

- In general, operate blowers between 8a.m. and 5p.m. on week day and 9a.m. to 5p.m. weekends. Avoid using blower late at night and/or early in the morning.
- Loosen compacted leaves, grass or debris with a rake or broom beforehand, so that the lowest possible throttle setting would get the job done.
- In dusty conditions, slightly dampen surfaces or use mister attachment when water is available.
- Check if the air filter, air intakes and muffler are working properly.
- Never use more than one unit of the blower at a time.

■ AVOID CHANCES OF DAMAGE

- Avoid directing the blower nozzle toward persons, pets, cars, windows or anything that could be harmed by blowing debris or dust.
- Keep the nozzle at full extension when operating so as to make the air stream close to the ground.
- Collect any trash and leaves and put them into a proper container after the job is done.
- Always check to be sure that no debris has been blown onto someone else's property.

Symbols on the machine

For safe operation and maintenance, symbols are carved in relief on the machine. According to these indications, please be careful not to take a mistake.



(a)

(a) The port to refuel the "MIX GASOLINE"

Position: FUEL TANK CAP



(b)

(b) The direction to close the choke

Position: AIR CLEANER BODY



(c)

(c) The direction to open the choke

Position: AIR CLEANER BODY

IMPORTANT ENGINE INFORMATION

THIS ENGINE MEETS U.S. EPA PH2 AND 2001 CALIFORNIA EMISSION REGULATIONS FOR SI SORE's COMPLIANCE PERIOD : CATEGORY A
ENGINE FAMILY : 1KZXS.0254QR ; EM
ENGINE DISPLACEMENT : 25.4cc
REFER TO OWNER'S MANUAL FOR MAINTENANCE SPECIFICATIONS AND ADJUSTMENTS.

KOMATSU ZENOAH CO. MADE IN JAPAN



Use RedMax 50:1 Oil !

INFORMATION IMPORTANTE CONCERNANT LE MOTEUR

Ce moteur est conforme aux normes U.S. EPA PH2 et 2001 ainsi qu'aux autres dispositions ultérieures de la réglementation concernant la pollution de l'air pour les petits moteurs tout-terrain avec une période de accordable : CATEGORY A
Type de moteur : 1KZXS.0254QR :EM
Cylindrée du moteur : 25,4cc
Se référer au Manuel de l'utilisateur pour les spécifications d'entretien et les réglages.

KOMATSU ZENOAH CO. MADE IN JAPAN



Use RedMax 50:1 Oil !

Parts Location & Specifications

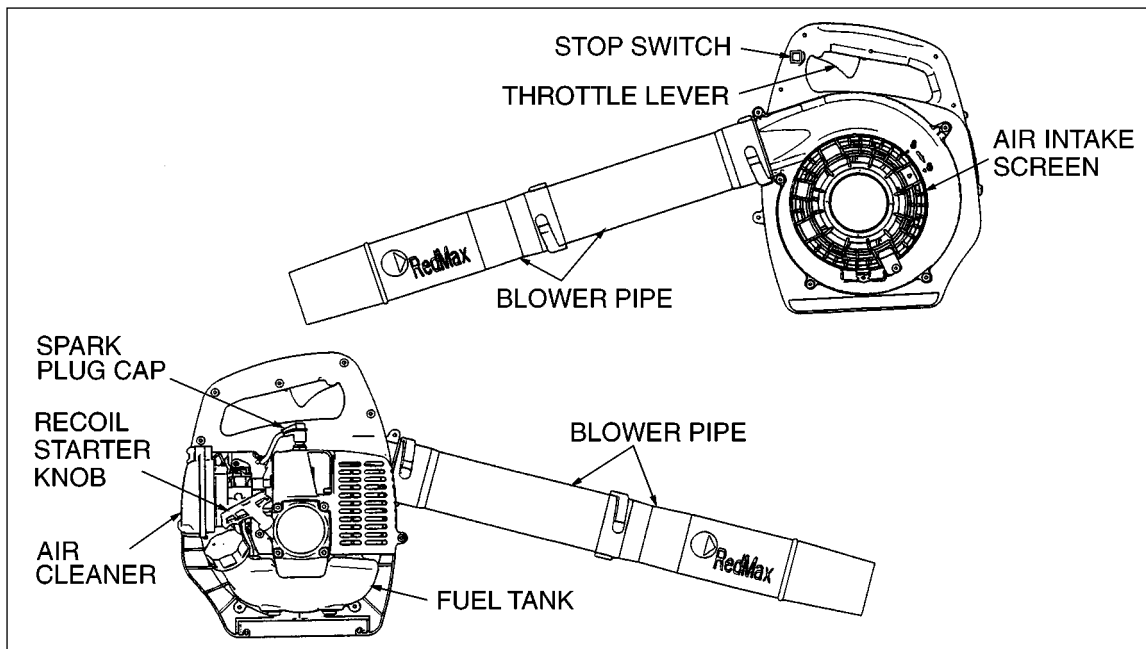

MODEL HBZ2500

Dimensions (L x W x H)	mm (in)	327 x 273 x 360 (12.9 x 10.7 x 14.2)
Dry Weight (without tube and nozzle)	kg (lbs)	3.8 (8.4)
Fuel Tank Capacity	liter (fl. oz)	0.65 (22.0)
Engine Type		Air cooled 2-cycle gasoline engine
Piston Displacement	cm ³ (cu. in)	25.4 (1.60)
Durability Period		300h
Carburetor		Walbro Diaphragm type
Ignition System		CDI
Spark Plug		NGK CMR7A
Muffler		Spark arrester equipped
Operating Engine Speed	rpm	2.800 ~ 7.890
Idle Speed	rpm	2.800
Max. Air Volume	cu. m/min (cfm)	10.4 (367)
Max. Air Velocity	m/sec (mph)	70 (157)
Noise Level (ANSI B175.2-2000)	db (A)	69

Assembly

■ BLOWER PIPE

- Align groove in blower pipe with projection on blower housing (or another blower pipe) and slide the pipe onto the blower housing (or another blower pipe).

Rotate the pipe clockwise to lock it into place.

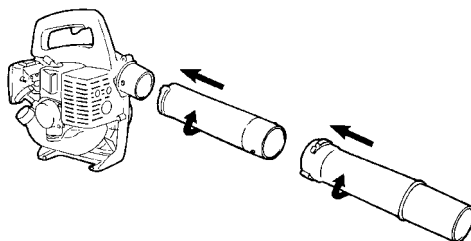

Fuel

⚠ WARNING

- **Gasoline is very flammable. Avoid smoking or bringing any flame or sparks near fuel. Make sure to stop the engine and allow it cool before refueling the unit. Select outdoor bare ground for fueling and move at least 3m(10ft) away from the fueling point before starting the engine.**



- The RedMax engines are lubricated by oil specially formulated for air-cooled 2-cycle gasoline engine use. If RedMax oil is not available, use an anti-oxidant added quality oil expressly labeled for air-cooled 2-cycle engine use. (JASO FC GRADE OIL or ISO EGC GRADE)

RECOMMENDED MIXING RATIO GASOLINE 50:OIL 1

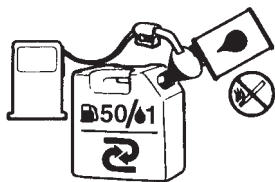

50:1 MIXING CHART

GASOLINE	gal.	1	2	3	4	5
2-CYCLE OIL	fl.oz	2.6	5.2	7.8	10.4	13

GASOLINE	liter	1	2	3	4	5
2-CYCLE OIL	ml	20	40	60	80	100

- **Exhaust emission are controlled by the fundamental engine parameters and components(eq., carburation, ignition timing and port timing) without addition of any major hardware or the introduction of an inert material during combustion.**
- These engines are certified to operate on unleaded gasoline.
- Make sure to use gasoline with a minimum octane number of 90 ROZ(USA/Canada : pump octane min.87)

- Unleaded gasoline is recommended to reduce the contamination of the air for the sake of your health and the environment.
- Poor quality gasolines or oils may damage sealing rings, fuel lines or fuel tank of the engine.

■ HOW TO MIX FUEL

1. Measure out the quantities of gasoline and oil to be mixed.
2. Put some of the gasoline into a clean, approved fuel container.
3. Pour in all of the oil and agitate well.
4. Pour in the rest of gasoline and agitate again for at least one minute.
5. Put a clear indication on the outside of the container to avoid mixing up with gasoline or other containers.
6. Indicate the contents on outside of container for easy identification.

■ FUELING THE UNIT

1. Untwist and remove the fuel cap. Rest the cap on a dustless place.
2. Put fuel into the fuel tank to 80% of the full capacity.
3. Fasten the fuel cap securely and wipe up any fuel spillage around the unit.

⚠ WARNING

1. Select bare ground for fueling.
2. Move at least 10 feet (3 meters) away from the fueling point before starting the engine.
3. Stop the engine before refueling the unit.

FOR YOUR ENGINE LIFE, AVOID;

1. **FUEL WITH NO OIL(RAW GASOLINE)** – It will cause severe damage to the internal engine parts very quickly.
2. **GASOHOL** – It can cause deterioration of rubber and/or plastic parts and disruption of engine lubrication.
3. **OIL FOR 4-CYCLE ENGINE USE or WATER COOLED 2-CYCLE ENGINE USE** – It can cause spark plug fouling, exhaust port blocking, or piston ring sticking.
4. **Mixed fuels which have been left unused for a period of one month or more** may clog the carburetor and result in the engine failing to operate properly.

Operation

■ STARTING ENGINE

1. Rest the unit on a flat, firm place.
2. Pump the primer until fuel flows out in the clear tube.

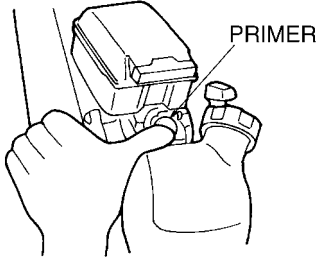

3. Move the choke lever upward to close the choke.

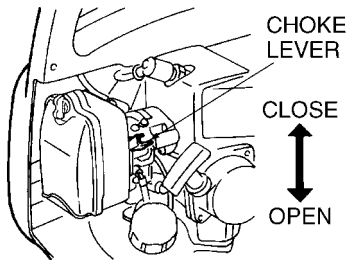

4. Holding the blower handle, pull the starter rope with your right hand. (Throttle lever in idling position.)

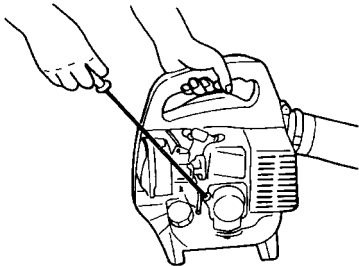

NOTE

Avoid pulling the rope to its dead end or returning it by releasing the knob. Such actions can cause starter failures.

5. When the engine has started, move the choke lever gradually downward to open the choke.
6. Allow the engine to warm up for a half minute before starting operation.

■ RESTARTING ENGINE WHILE ENGINE IS HOT

1. When restarting the engine immediately after stopping it, leave the choke open.
2. If the engine won't start after several attempts, close the choke and repeat pulling the rope or remove the spark plug and dry it.

■ STOPPING ENGINE

Move the throttle lever to the idling position and press the stop switch (red button) until the engine comes to a complete stop.

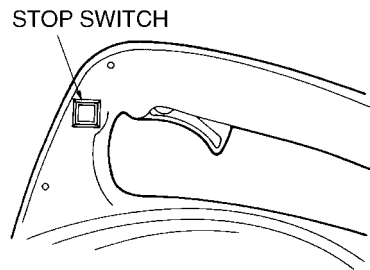

NOTE

Except for an emergency, avoid stopping the engine while pulling the throttle lever.

■ ADJUSTING IDLE SPEED

1. When the engine tends to stop frequently at an idle mode, turn the adjusting screw clockwise.

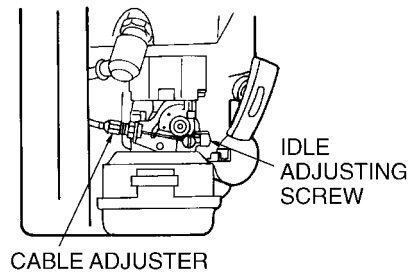

NOTE

Warm up the engine before adjusting the idle speed.

Maintenance

⚠ WARNING

- Make sure that the engine has stopped and is cool before performing any service to the blower. Contact with rotating blower fan or hot muffler may result in a personal injury.

■ AIR CLEANER

- Check the air cleaner every 25 hours of use or more frequently if used under dusty conditions. A clogged air filter may increase fuel consumption while cutting down the engine power. Never operate the blower without the air filter or with a deformed filter element because unfiltered dusty air will quickly ruin the engine.

CLEANING AIR FILTER:

1. Remove the air cleaner cover by pulling the tab on bottom and take out the filter element.

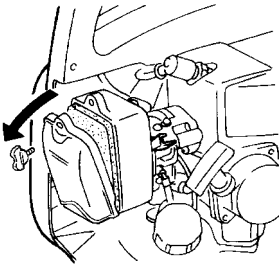

2. Use neutral detergent and warm water to clean the filter element. After cleaning, air dry the element completely. Place the filter element into the air cleaner housing and press the cover against the housing until it clicks. Never forget to attach the screen. If the screen is not attached, the cleaner will not seal properly and the dusts come into the cylinder.

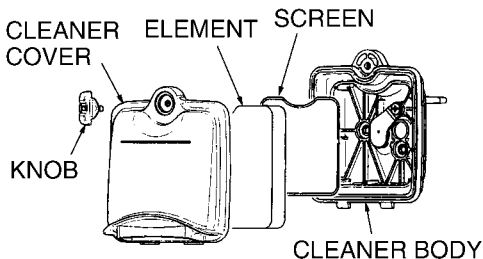

■ FUEL FILTER

- A clogged fuel filter may cause poor acceleration of the engine. Check periodically to see if the filter is clogged with dirt. The filter can be taken out of the fueling port using a small wire hook. Disconnect the filter assembly from the fuel pipe and unhook the retainer to disassemble it. Clean the components with gasoline.

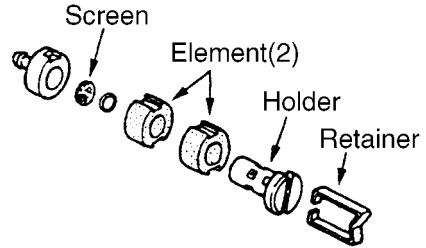

■ SPARK PLUG

- The spark plug may gather carbon deposits on its firing end with reasonable use. Remove and inspect the spark plug every 25 hours and clean the electrodes as necessary with a wire brush. The spark gap should be adjusted to .025in. (0.6~0.7mm).

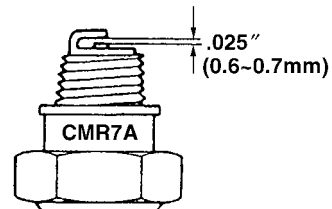

- Plug manufacturers recommend replacing the plug twice a year to avoid unexpected plug failure in a job.

REPLACEMENT PLUG IS A NGK CMR7A.

IMPORTANT

- Note that using any spark plugs other than those designated may result in the engine failing to operate properly or in the engine becoming overheated and damaged.
- To install the spark plug, first turn the plug until it is finger tight, then tighten it a quarter turn more with a socket wrench.

Maintenance

■ MUFFLER

⚠ WARNING

- Inspect periodically the muffler for loose fasteners, any damage or corrosion. If any sign of exhaust leakage is found, do not use the blower and have it repaired immediately.
- **Note that failing to do so may result in the engine catching on fire.**

IMPORTANT

- Before starting operation, always make sure to check if the muffler is properly held by two bolts to the cylinder. (Fastening Torque: 70~110kg-cm)
- Even if one bolt out of three bolts is loose, the muffler may get loose during operation which may result in engine catching on fire.

■ SPARK ARRESTER

- The muffler is equipped with a spark arrester to prevent red hot carbon from flying out of the exhaust outlet. Periodically inspect and clean as necessary with a wire brush. In the State of California it is required by law (Section 4442 of the California Public Resources Code) to equip a spark arrester when a gas powered tool is used in any forest covered, brush covered, or grass covered unimproved land.

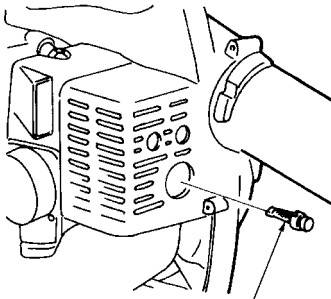

SPARK ARRESTER

■ AIR INLET SCREEN

IMPORTANT

- Blowing air is taken in from the air inlet screen. When air flow has dropped down during operation, stop the engine and inspect the air inlet screen for blocking by obstacles.
- Note that failure to remove any such obstacles may result in the engine becoming overheated and damaged.

⚠ WARNING

- **Never use the blower without the screen at the air intake of the blower. Before each use, check that the screen is attached in place and is free from any damage.**

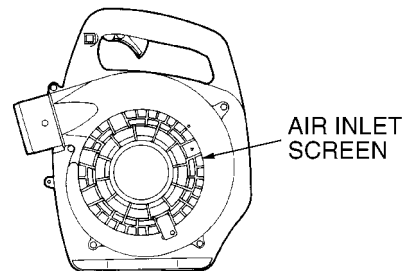

AIR INLET SCREEN

Maintenance

■ HOW TO INSTALL THE AIR INLET SCREEN TO THE VOLUTE COVER

- Put the mark \triangle of the air inlet screen to the mark \circ of the volute cover in line.
- Turn the air inlet screen clockwise (arrow direction) and make sure it is firmly installed.

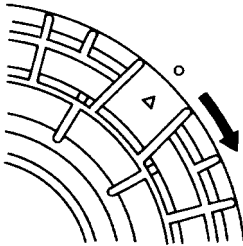

- Install the screw through the stopper to insure that the air inlet screen does not move

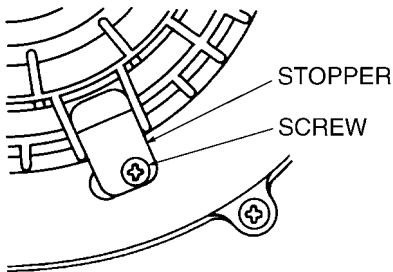

■ PROCEDURES TO BE PERFORMED AFTER EVERY 100 HOURS OF USE

- Remove the muffler, insert a screwdriver into the vent, and wipe away any carbon buildup. Wipe away any carbon buildup on the muffler exhaust vent and cylinder exhaust port at the same time.
- Tighten all screws, bolts, and fittings.

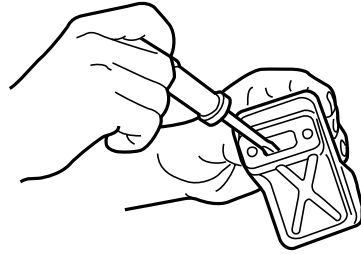

Storage

BEFORE STORING THE BLOWER:

1. Drain a fuel tank and push the primer bulb until it becomes empty of fuel.
2. Remove the spark plug and drop a spoonful of 2-cycle oil into the cylinder. Crank the engine several time and install the spark plug.

Troubleshooting guide

Case 1. Starting failure

CHECK		PROBABLE CAUSES		ACTION
fuel tank	→	incorrect fuel	→	drain it and with correct fuel
fuel filter	→	fuel filter is clogged	→	clean
carburetor adjustment screw	→	out of normal range	→	adjust to normal range
sparkling (no spark)	→	spark plug is fouled/wet	→	clean/dry
	→	plug gap is incorrect	→	correct (GAP: 0.6~0.7mm)
spark plug	→	disconnected	→	retighten

Case 2. Engine starts but does not keep running/Hard re-starting.

CHECK		PROBABLE CAUSES		ACTION
fuel tank	→	incorrect fuel or staled fuel	→	drain it and with correct fuel
carburetor adjustment screw	→	out of normal range	→	adjust to normal range
muffler,cylinder (exhaust port)	→	carbon is built-up	→	wipe away
air cleaner	→	clogged with dust	→	wash

When your unit seems to need further service, please consult with our RedMax service shop in your area.

HANDHELD BLOWER

HBZ2500

NOTE :

1. Use KOMATSU ZENOAH genuine parts as specified in the parts list for repair and/or replacement.
2. KOMATSU ZENOAH does not warrant the machines, which have been damaged by the use of any parts other than those specified by the company.
3. When placing parts orders for repair and/or replacement, check if the model name and the serial number are applicable to those specified in the parts list, then use parts number described in the parts list.
4. The contents described in the parts list may change due to improvement.
5. The parts for the machine shall be supplied seven (7) years after the machine is discontinued. [It is possible that some specific parts may be subject to change of their delivery term and list price within the limit of seven (7) years after the machine is discontinued. It is also possible that some parts may be available even after the limit of seven (7) years.]

Nov. 2001

APPLICABLE SERIAL NUMBERS :

DRIVE UNIT 100101 and up

ENGINE UNIT 100101 and up

Parts List

Fig.1 ENGINE GROUP HBZ2500

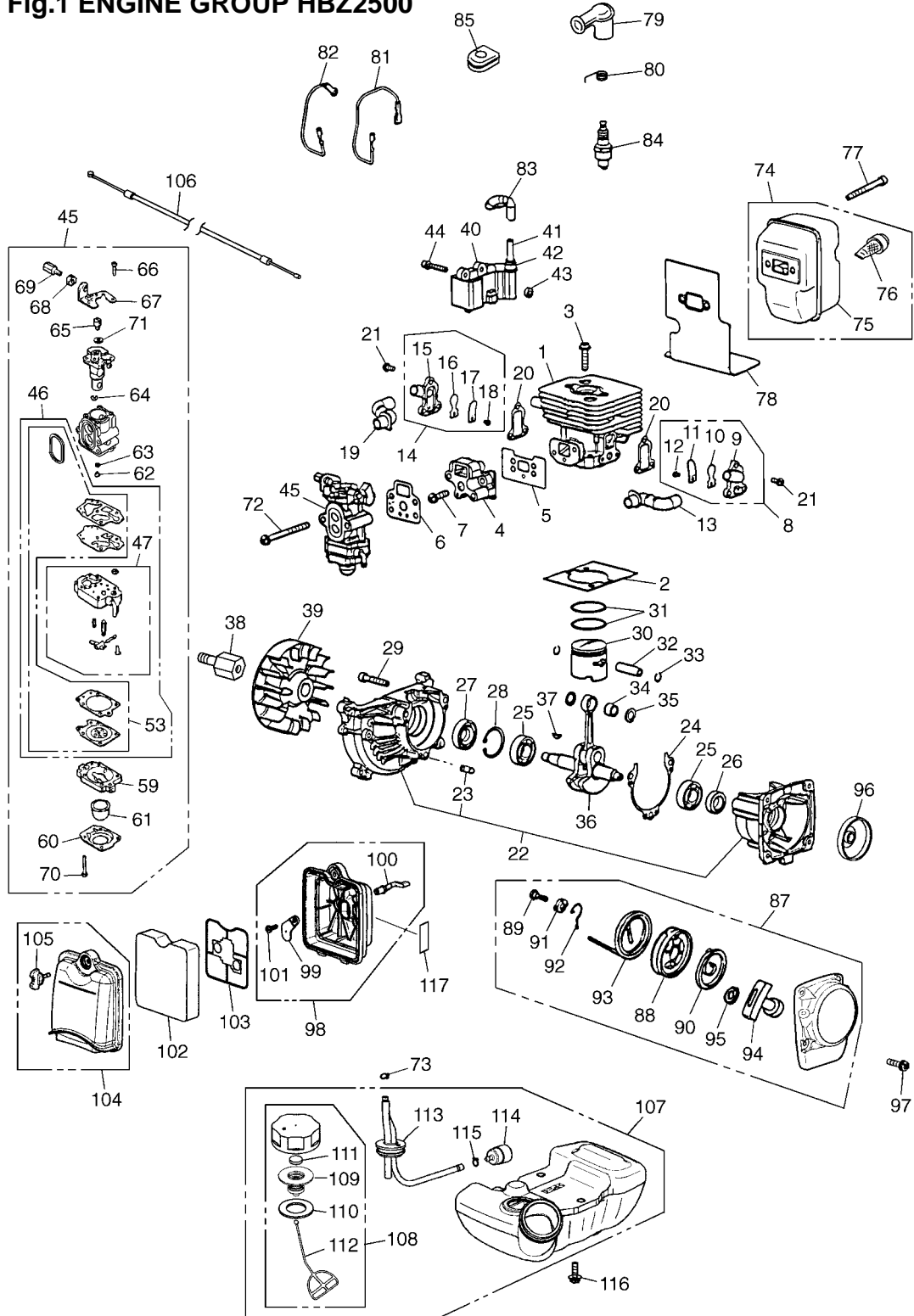

Fig.1 ENGINE GROUP HBZ2500

Key#	Part Number	Description	Q'ty	Key#	Part Number	Description	Q'ty
1	4810-12111	CYLINDER	1	61	1751-81510	• PUMP, priming	1
2	4810-12210	GASKET	1	62	4810-81251	• JET, #38.5	1
3	4820-12130	BOLT TORX, M5x22	2	63	1751-81240	• O-RING	1
4	4810-13162	INSULATOR	1	64	1751-81130	• RING	1
5	T1512-13120	GASKET, INSU	1	65	1881-81140	• SWIVEL	1
6	4810-13130	GASKET, CARB	1	66	1752-81110	• SCREW	2
7	4820-13180	BOLT TORX, M5x20	2	67	5500-81120	• BRACKET	1
8	4810-16100	REEDVALVE-A(S)	1	68	1751-81180	• NUT, adjuster	1
9	4810-16110	• VALVECASE(S)	1	69	1918-81170	• SCREW, adjuster	1
10	4810-16120	• REEDVALVE	1	70	1850-81530	• SCREW	4
11	4810-16130	• STOPPER	1	71	5500-81160	• WASHER	1
12	4810-16170	• SCREW, M3x8	1	72	4820-82310	BOLT TORX, M5x60	2
13	4810-16150	PIPE, AIR S	1	73	1950-86120	CLIP	1
14	4810-16200	REEDVALVE-A(F)	1	74	T1513-15100	MUFFLER-A	1
15	4810-16210	• VALVECASE(F)	1	75	T1513-15110	• MUFFLER	1
16	4810-16120	• REEDVALVE	1	76	4810-15140	• ARRESTER	1
17	4810-16130	• STOPPER	1	77	T4950-57030	BOLT TORX, M5x70	2
18	4810-16170	• SCREW, M3x8	1	78	T1513-15210	GASKET, MUFF	1
19	4810-16160	PIPE, AIR F	1	79	T2070-72210	CAP	1
20	4810-16140	GASKET, VALVE	2	80	1900-72120	SPRING	1
21	4820-16310	BOLT TORX, M4x10	6	81	4810-71240	CORD	1
22	4810-21101	CRANKCASE-C	1	82	4810-71250	CORD EARTH	1
23	2629-21130	• PIN	3	83	T1513-71320	TUBE	1
24	4810-21140	GASKET, CASE	1	84	4810-73110	SPARK PLUG, NGK CMR7A	1
25	06030-06001	BEARING	2	85	5500-72130	GROMMET	1
26	4810-21210	SEAL	1				
27	1850-21220	SEAL	1	87	4810-75100	RECOIL-A	1
28	04065-02812	SNAPRING	1	88	4500-75120	• REEL	1
29	4820-21310	BOLT TORX, M5x30	3	89	4500-75150	• SCREW	1
30	4810-41110	PISTON	1	90	1850-75130	• SPRING	1
31	5910-41210	RING	2	91	4500-75180	• COLLAR	1
32	1600-41310	PIN	1	92	4500-75190	• ARM	1
33	1260-41320	SNAPRING	2	93	4810-75160	• ROPE	1
34	5500-41410	BEARING	1	94	3330-75421	• KNOB	1
35	1101-41340	WASHER	2	95	4810-75170	• PLATE	1
36	4810-42000	CRANKSHAFT-C	1	96	4500-75210	PULLEY	1
37	1000-43240	KEY	1	97	4820-85510	BOLT TORX, M5x16	2
38	5516-43230	EXTENTION	1	98	T1513-82100	BODY-A	1
39	4810-71110	ROTOR	1	99	T1512-82130	• PLATE, CHOKE	1
40	T1513-71200	COIL-A	1	100	T1600-82140	• LEVER	1
41	T1513-71220	• CORD	1	101	T1108-82190	• SCREW	1
42	2616-71320	• CAP	1	102	T1513-82170	ELEMENT	1
43	1260-71261	SPACER	2	103	T1513-82180	PLATE	1
44	4820-72150	BOLT TORX	2	104	T1513-82200	COVER-A	1
45	T1513-81000	CARBURETOR-A, WYA-26	1	105	T1108-82220	• KNOB	1
46	4810-06030	• REBUILD KIT	1	106	5516-83101	CABLE	1
47	4810-81450	•• BODY ASS'Y	1	107	T1504-85001	TANK-A	1
	-	••• SCREEN	1	108	T1015-85202	• CAP-A	1
	-	••• VALVE	1	109	4500-85300	•• HOLDER-A	1
	-	••• SPRING	1	110	4500-85220	•• PACKING	1
	-	••• PIN	1	111	5601-85260	•• FILTER	1
	-	••• LEVER	1	112	4820-85260	•• STOPPER	1
53	4810-06021	•• GASKET KIT	1	113	4810-85300	• PIPE-C	1
	-	••• DIAPHRAGM	1	114	5500-85400	• FILTER-A	1
	-	••• GASKET, diaphragm	1	115	1260-85460	• CLIP	1
	-	••• DIAPHRAGM, pump	1	116	4820-85510	BOLT TORX, M5x16	3
	-	••• GASKET, pump	1	117	1133-82060	LABEL, CHOKE	1
	-	••• RING	1				
59	1850-81490	• BODY, purge	1				
60	1850-81520	• COVER, pump	1				

Parts List

Fig.2 BLOWER GROUP HBZ2500

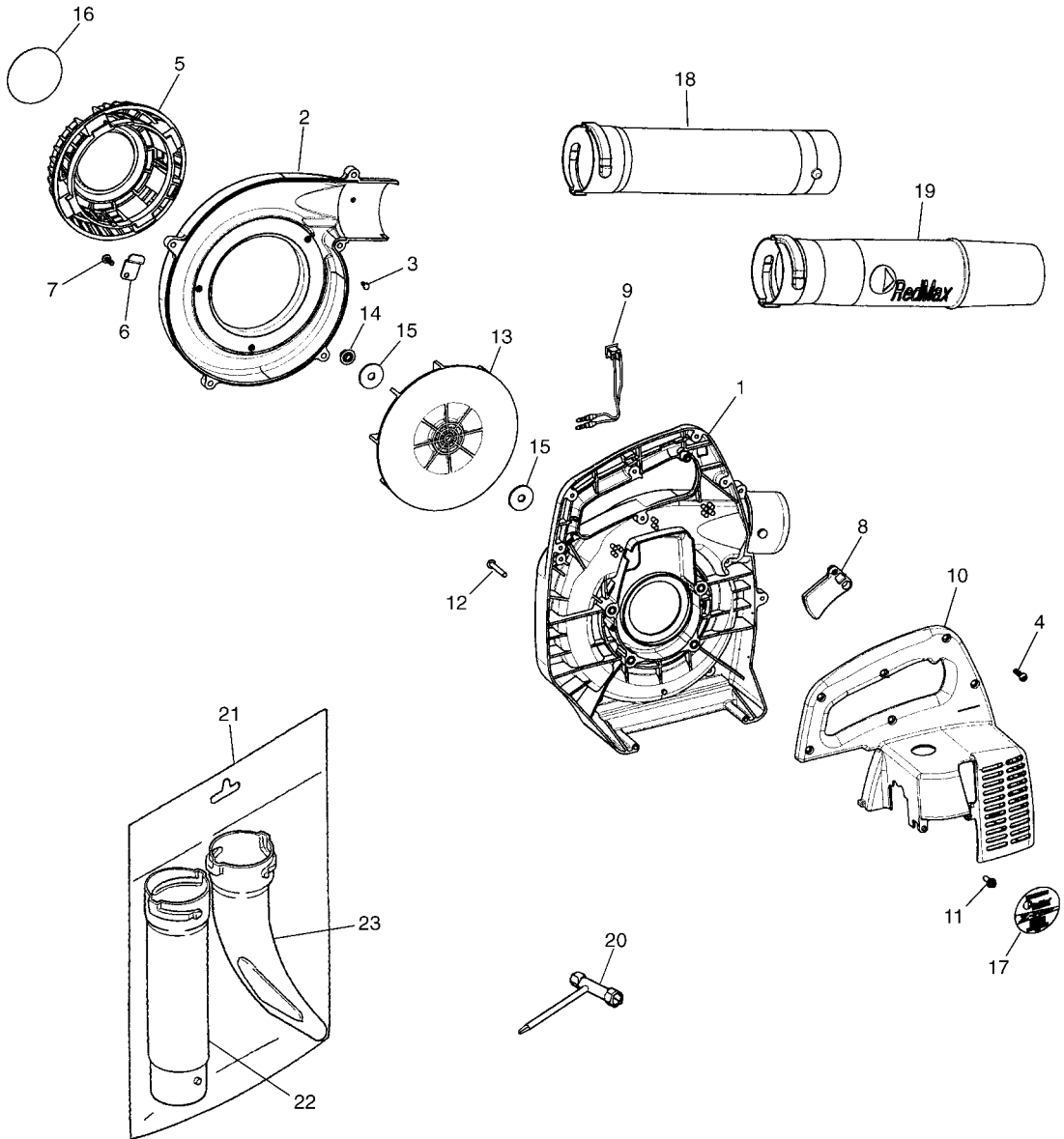

Fig.2 BLOWER GROUP HBZ2500

Key#	Part Number	Description	Q'ty	Key#	Part Number	Description	Q'ty
1	6811-11110	VOLUTE CASE	1				
2	T4022-11300	VOLUTE COVER-A	1				
3	1600-33130	SCREW	3				
4	T4970-52001	SCREW TORX	12				
5	6811-11130	GURG NET	1				
6	6811-11160	STOPPER	1				
7	T4970-51410	SCREW TORX	1				
8	6811-11150	LEVER	1				
9	6811-72200	SWITCH	1				
10	T4022-11210	ENGINE COVER	1				
11	4820-85510	SCREW TORX	2				
12	T4960-53510	SCREW TORX	4				
13	6811-12110	FAN	1				
14	1650-43230	182301 NUT	1				
15	6811-12220	WASHER	2				
16	T4022-19110	LABEL, CAUTION	1				
17	T4022-75610	LABEL, RECOIL	1				
18	6811-51210	PIPE CT2-18	1				
19	6811-51220	PIPE, END CT2-19	1				
20	T4017-91130	SOCKET	1				
OPTION							
21	HBN-100	FLAT NOZZLE SET	1				
22	6811-51210	PIPE	1				
23	6811-51230	FLAT NOZZLE	1				

CALIFORNIA EMISSION CONTROL WARRANTY STATEMENT
YOUR WARRANTY RIGHTS AND OBLIGATIONS

THE CALIFORNIA AIR RESOURCES BOARD AND KOMATSU ZENOAH Co. ARE PLEASED TO EXPLAIN THE **EMISSION CONTROL SYSTEM WARRANTY** ON YOUR **1995 AND LATER** LAWN AND GARDEN EQUIPMENT ENGINE. IN CALIFORNIA, NEW UTILITY AND LAWN AND GARDEN EQUIPMENT ENGINES MUST BE DESIGNED, BUILT AND EQUIPPED TO MEET THE STATE'S STRINGENT ANTI-SMOG STANDARDS.

KOMATSU ZENOAH Co, MUST WARRANT THE EMISSION CONTROL SYSTEM ON YOUR LAWN AND GARDEN EQUIPMENT ENGINE FOR THE PERIODS OF TIME LISTED BELOW PROVIDED THERE HAS BEEN NO ABUSE, NEGLIGENCE OR IMPROPER MAINTENANCE OF YOUR LAWN AND GARDEN EQUIPMENT ENGINE.

YOUR EMISSION CONTROL SYSTEM MAY INCLUDE PARTS SUCH AS THE CARBURETOR, THE IGNITION SYSTEM, AND CATALYTIC CONVERTER. ALSO INCLUDED MAY BE THE HOSES, BELTS, CONNECTORS AND OTHER EMISSION-RELATED ASSEMBLIES.

WHERE A WARRANTABLE CONDITION EXISTS, KOMATSU ZENOAH Co. WILL REPAIR YOUR LAWN AND GARDEN EQUIPMENT ENGINE AT NO COST TO YOU INCLUDING DIAGNOSIS, PARTS AND LABOR.

MANUFACTURER'S WARRANTY COVERAGE:

THE 1995 AND LATER UTILITY AND LAWN AND GARDEN EQUIPMENT ENGINES ARE WARRANTED FOR **TWO YEARS**. IF ANY EMISSION-RELATED PART ON YOUR ENGINE IS DEFECTIVE, THE PART WILL BE REPAIRED OR REPLACED BY KOMATSU ZENOAH Co.

OWNER'S WARRANTY RESPONSIBILITIES:

- AS THE LAWN AND GARDEN EQUIPMENT ENGINE OWNER, YOU ARE RESPONSIBLE FOR THE PERFORMANCE OF THE **REQUIRED MAINTENANCE LISTED IN YOUR OWNER'S MANUAL**. KOMATSU ZENOAH Co. RECOMMENDS THAT YOU RETAIN ALL RECEIPTS COVERING MAINTENANCE ON YOUR LAWN AND GARDEN ENGINE, BUT KOMATSU ZENOAH Co. CAN NOT DENY WARRANTY SOLELY FOR THE LACK OF RECEIPTS OR FOR YOUR FAILURE TO ENSURE THE PERFORMANCE OF ALL SCHEDULED MAINTENANCE.

- AS THE LAWN AND GARDEN EQUIPMENT ENGINE OWNER, YOU SHOULD HOWEVER BE AWARE THAT KOMATSU ZENOAH Co. MAY DENY YOU WARRANTY COVERAGE IF YOUR LAWN AND GARDEN EQUIPMENT ENGINE OR A PART HAS FAILED DUE TO ABUSE, NEGLIGENCE, IMPROPER MAINTENANCE OR UNAPPROVED MODIFICATION.

- YOU ARE RESPONSIBLE FOR PRESENTING YOUR LAWN AND GARDEN EQUIPMENT ENGINE TO A KOMATSU ZENOAH Co. DISTRIBUTION CENTER AS SOON AS A PROBLEM EXISTS. THE WARRANTY REPAIRS SHOULD BE COMPLETED IN A REASONABLE AMOUNT OF TIME, NOT TO EXCEED **30 DAYS**.

IF YOU HAVE ANY QUESTIONS REGARDING YOUR WARRANTY RIGHTS AND RESPONSIBILITIES, YOU SHOULD CONTACT KOMATSU ZENOAH AMERICA INC. AT (770)-381-5147.

RedMax
MODEL HBZ2500
2-YEAR LIMITED WARRANTY

EMISSION-RELATED PARTS; FOR TWO (2) YEARS FROM THE DATE OF ORIGINAL DELIVERY OF THE MODEL HBZ2500 UNIT, KOMATSU ZENOAH AMERICA INC. (THE COMPANY), THROUGH ANY RedMax DEALER, WILL REPAIR OR REPLACE, FREE OF CHARGE, FOR THE ORIGINAL AND EACH SUBSEQUENT PURCHASER, ANY PART OR PARTS FOUND TO BE DEFECTIVE IN MATERIAL AND/OR WORKMANSHIP. EMISSION-RELATED PARTS ARE:

**THE CARBURETOR ASSY, COIL ASSY, ROTOR, SPARK PLUG,
AIR FILTER, FUEL FILTER, INTAKE MANIFOLD, AND THE GASKETS**

ALL OTHER PARTS EXCEPT ABOVE PARTS; FOR TWO (2) YEARS OF HOME USE [ONE (1) YEAR FOR ANY OTHER USE] FROM THE DATE OF ORIGINAL ANY DELIVERY OF THE MODEL HBZ2500 UNIT, THE COMPANY, THROUGH ANY RedMax DEALER, WILL REPAIR OR REPLACE, FREE OF CHARGE, FOR THE ORIGINAL PUSHCHASER, ANY PART OR PARTS FOUND TO BE DEFECTIVE IN MATERIAL AND/OR WORKMANSHIP. **THIS IS THE EXCLUSIVE REMEDY.**

THE PURCHASER SHALL BEAR COSTS OF TRANSPORTING THE UNIT TO AND FROM THE RedMax DEALER.

THE PURCHASER SHALL NOT BE CHARGED FOR DIAGNOSTIC LABOR WHICH LEADS TO THE DETERMINATION THAT A WARRANTED PART IS DEFECTIVE, IF THE DIAGNOSTIC WORK IS PERFORMED AT THE RedMax DEALER.

THE PURCHASER OR OWNER IS RESPONSIBLE FOR THE PERFORMANCE OF THE REQUIRED MAINTENANCE AS DEFINED BY THE MANUFACTURER IN THE OWNER/OPERATOR MANUAL.

ANY WARRANTED PART WHICH IS NOT SCHEDULED FOR REPLACEMENT AS REQUIRED MAINTENANCE, OR WHICH IS SCHEDULED ONLY FOR REGULAR INSPECTION TO THE EFFECT OF "REPAIR OR REPLACE AS NECESSARY" SHALL BE WARRANTED FOR THE WARRANTY PERIOD. ANY WARRANTED PART WHICH IS SCHEDULED FOR REPLACEMENT AS REQUIRED MAINTENANCE SHALL BE WARRANTED FOR THE PERIOD OF TIME UP TO THE FIRST SCHEDULED REPLACEMENT POINT FOR THAT PART.

ANY REPLACEMENT PART THAT IS EQUIVALENT IN PERFORMANCE AND DURABILITY MAY BE USED IN NON-WARRANTY MAINTENANCE OR REPAIRS, AND SHALL NOT REDUCE THE WARRANTY OBLIGATION OF THE COMPANY.

THE COMPANY IS LIABLE FOR DAMAGES TO OTHER ENGINE COMPONENTS CAUSED BY THE FAILURE OF A WARRANTED PARTS STILL UNDER WARRANTY.

THIS WARRANTY DOES NOT APPLY TO THOSE UNITS WHICH HAVE BEEN DAMAGED BY NEGLIGENCE OF INSTRUCTION LISTED IN THE OWNER/OPERATOR MANUAL FOR PROPER USE AND MAINTENANCE OF THE UNITS, ACCIDENT MISHANDLING, ALTERATION, ABUSE, IMPROPER LUBRICATION, USE OF ANY PARTS OR ACCESSORIES OTHER THAN THOSE SPECIFIED BY THE COMPANY, OR OTHER CAUSES BEYOND THE COMPANY'S CONTROL.

THIS WARRANTY DOES NOT COVER THOSE PARTS REPLACED BY NORMAL WEAR OR HARMLESS CHANGES IN THEIR APPEARANCE.

THERE ARE NO OTHER EXPRESS WARRANTIES.

IMPLIED WARRANTIES INCLUDING THOSE OF MERCHANTABILITY AND FITNESS FOR A PARTICULAR PURPOSE **ARE LIMITED TO TWO (2) YEARS OF HOME USE [ONE (1) YEAR FOR ANY OTHER USE] FROM THE ORIGINAL DELIVERY DATE.**

LIABILITIES FOR INCIDENTAL OR CONSEQUENTIAL DAMAGE UNDER ANY AND ALL WARRANTIES ARE EXCLUDED.

SOME STATES DO NOT ALLOW LIMITATION ON HOW LONG AN IMPLIED WARRANTY LASTS OR EXCLUSION OR LIMITATION OF INCIDENTAL OR CONSEQUENTIAL DAMAGES, SO THE ABOVE LIMITATION OR EXCLUSION MAY NOT APPLY TO YOU.

THIS WARRANTY GIVES YOU SPECIFIC LEGAL RIGHTS, AND YOU MAY ALSO HAVE OTHER RIGHTS WHICH VARY FROM STATE TO STATE.

IF YOU NEED TO OBTAIN INFORMATION ABOUT THE NEAREST SERVICE CENTER, PLEASE CALL KOMATSU ZENOAH AMERICA INC. AT (770)-381-5147.

IMPORTANT: YOU WILL RECEIVE A WARRANTY REGISTRATION CARD AT TIME OF PURCHASE. PLEASE FILL OUT THE CARD AND SEND IT TO RedMax / KOMATSU ZENOAH AMERICA WITHIN SEVEN (7) DAYS. BE SURE TO KEEP A COPY FOR YOUR RECORDS.



KOMATSU ZENOAH AMERICA INC.
4344 Shackleford Road Suite 500
Norcross, Georgia 30093

RedMax
Modèle HBZ2500
Garantie limitée à 2 ans

Pièces en rapport avec les émissions de gaz d'échappement : KOMATSU ZENOAH AMERICA INC., par l'intermédiaire de n'importe quel revendeur RedMax, réparera gratuitement ou remplacera gratuitement pour l'acheteur initial et chaque acheteur successif toute(s) pièce(s) se révélant de constitution et/ou de montage défectueux pendant deux (2) ans à compter de la date initiale de livraison d'une unité du modèle HBZ2500. Les pièces en rapport avec les émissions de gaz d'échappement sont:

**l'assemblage carburateur, l'assemblage bobine, le rotor, la bougie,
le filtre à air, le filtre à carburant, la tubulure d'admission et les joints**

Toutes autres pièces exceptées celles mentionnées ci-dessus : La société, par l'intermédiaire de n'importe quel revendeur RedMax, réparera gratuitement ou remplacera gratuitement pour l'acheteur initial toute(s) pièce (s) se révélant de constitution et/ou de montage défectueux pendant deux (2) ans en cas d'utilisation privée [un (1) an pour toute autre utilisation] à compter de la date de livraison initiale d'une unité du modèle HBZ2500. **Telles sont les limites de la garantie.**

Le coût du transport de l'unité jusqu'au revendeur RedMax et depuis celui-ci sera à la charge de l'acheteur.

L'acheteur ne supportera pas le coût de main d'œuvre du diagnostic qui amène à la conclusion qu'une pièce garantie est défectueuse, si ce diagnostic est effectué chez le revendeur RedMax.

L'acheteur ou propriétaire a pour responsabilité d'effectuer l'entretien obligatoire tel que défini par le fabricant dans le manuel du propriétaire/de l'utilisateur.

Toute pièce garantie dont le remplacement n'est pas prévu dans le cadre de l'entretien obligatoire, ou pour laquelle est seulement prévue une inspection périodique pour "remplacement ou réparation si nécessaire" sera garantie pour la période de garantie. Toute pièce garantie arrivée à l'échéance de son premier remplacement prévu sera garantie jusqu'à celui-ci.

Toute pièce de rechange équivalente en performance ou en durabilité peut être utilisée pour l'entretien hors-garantie ou les réparations hors-garantie, et ce sans réduire l'obligation de garantie incombant à la société.

La société sera tenue responsable des dommages aux autres composants du moteur causés par la défaillance de pièce(s) garantie(s) en période de garantie.

La garantie ne s'applique pas aux unités endommagées par suite de: négligence dans la mise en oeuvre des instructions spécifiées dans le manuel du propriétaire/de l'utilisateur en vue d'une utilisation et d'un entretien correct, fausse manœuvre accidentelle, modification, utilisation abusive, lubrification incorrecte, utilisation de pièces ou d'accessoires autres que ceux spécifiés par la société, ou autres causes hors du contrôle de la société.

Cette garantie ne couvre pas les pièces remplacées en raison de leur usure normale ou de changements d'apparence sans effets.

Il n'existe aucune autre garantie explicite.

Les garanties implicites, celles de négociabilité du produit et de son adaptabilité à un usage défini incluses, **sont limitées** à deux (2) ans pour un usage privé [un (1) an pour toute autre utilisation] à compter de la date initiale de livraison.

Les responsabilités pour les dommages conséquents ou incidents sont exclues de toutes les garanties.

Certaines provinces n'autorisant pas les limitations à la durée des garanties implicites, ou les exclusions ou limitations relatives aux dommages incidents ou conséquents, la limitation indiquée ci-dessus peut ne pas vous être applicable.

Cette garantie vous donne des droits juridiques spécifiques, et vous pouvez également jouir d'autres droits variant d'une province à l'autre.

Si vous désirez obtenir des informations sur le centre de service le plus proche, veuillez appeler KOMATSU ZENOAH AMERICA INC. au (770)-381-5147

Note importante: vous recevrez une carte d'enregistrement de garantie au moment de l'achat. Veuillez la remplir et l'adresser à RedMax / KOMATSU ZENOAH AMERICA sous sept (7) jours en prenant soin de conserver une copie pour vous.



KOMATSU ZENOAH AMERICA INC.
4344 Shackelford Road Suite 500
Norcross, Georgia 30093