



U
S

OWNER'S/OPERATOR'S MANUAL

BACKPACK BLOWER

EBZ8050
EBZ8050RH

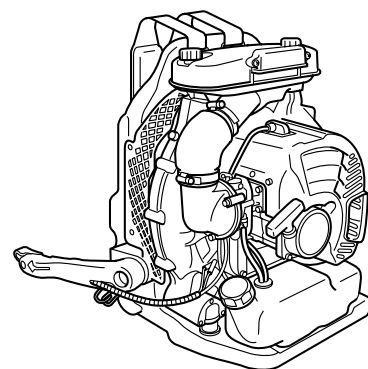

! WARNING !

The engine exhaust from this product contains chemicals known to the State of California to cause cancer, birth defects or other reproductive harm.

! WARNING !

Before using our products, please read this manual carefully to understand the proper use of your unit.

APPLICABLE SERIAL NUMBERS :

90100101 and up

SAFETY FIRST

Instructions contained in warnings within this manual and warning seals marked with a  symbol on the blower concern critical points which must be taken into consideration to prevent possible serious bodily injury, and for this reason you are requested to read all such instructions carefully and follow them without fail.

Note that there may be times when warning seals peel off or become soiled and impossible to read. If this happens, you should contact the dealer from which you purchased the product to order new seals and affix the new seal(s) in the required location(s).



■ NOTES ON TYPES OF WARNINGS

WARNING

Instructions labeled as shown at left, concern critical steps or procedures which must be followed in order to prevent accidents which could lead to serious bodily injury or death. This mark is used to indicate instructions which must be followed without exception.

IMPORTANT

Instructions labeled as shown at left concern steps or procedures which, if not followed correctly, could lead to mechanical failure, breakdown, or damage.

NOTE

Used to label supplementary instructions designed to provide hints or directions useful in the use of the product.

WARNING

1. Read this Blower Owner/Operator Manual carefully. Be sure you understand how to operate this unit properly before you use it. Failure to do so could result in serious injury.
2. Be sure to keep this manual handy so that you may refer to it later whenever any questions arise. Also note that you are requested to contact the dealer from whom you purchased the product for assistance the event that you have any questions which cannot be answered herein.
3. Always be sure to include this manual when selling, lending, or otherwise transferring the ownership of this product.
4. Do not lend or rent your machine without the owner's manual.
5. Be sure that anyone using your unit understands the information contained in this manual.
6. Never let a child under 13 years old use the machine.

Contents

1. Parts location	3
2. Specifications	3
3. Warning labels on the machine	4
4. Symbols on the machine	4
5. For safe operation	5
6. Set up	8
7. Fuel.....	9
8. Operation.....	11
9. Maintenance	13
10. Storage	16
11. Disposal.....	16
12. Troubleshooting guide	16

1. Parts location

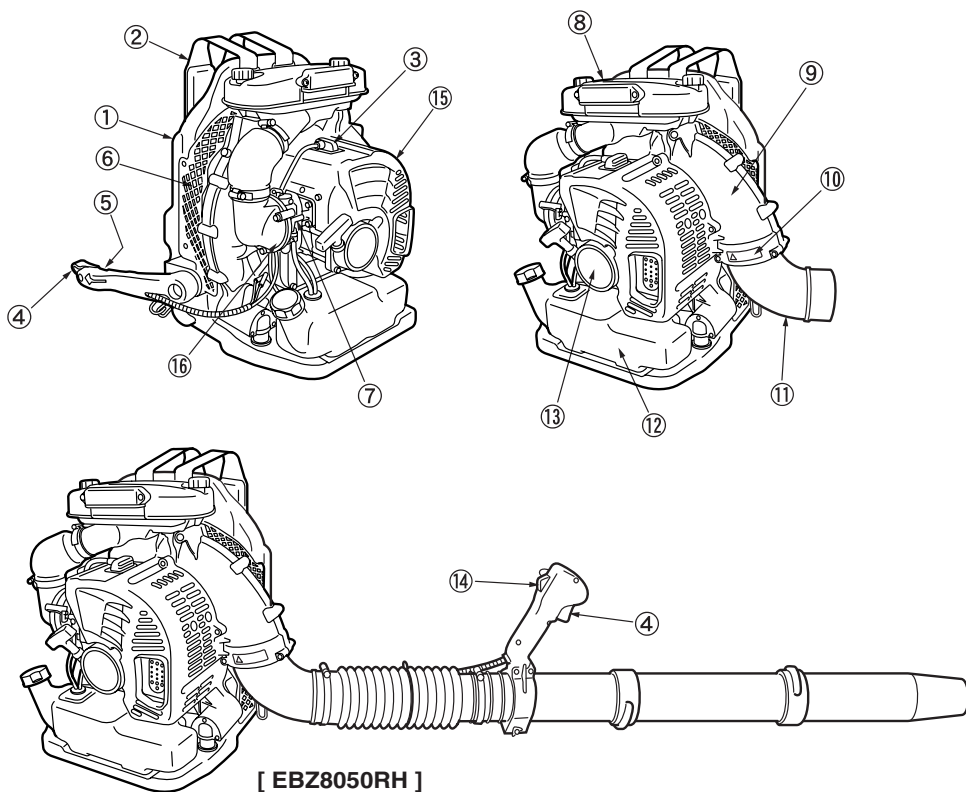

- 1. Frame
- 2. Shoulder Strap
- 3. Spark Plug Cap
- 4. Throttle Lever
- 5. Stop Switch (behind)
- 6. Net
- 7. Choke Lever
- 8. Air Cleaner
- 9. Volute Case
- 10. "CAUTION" Label
- 11. Elbow
- 12. Fuel Tank
- 13. Recoil Starter
- 14. Ignition Switch
- 15. Engine Cover
- 16. Intake Cup

2. Specifications

■ MODEL EBZ8050/EBZ8050RH

Dimensions (L x W x H) mm (in)	
EBZ8050	390x540x496 (15.4x21.3x19.5)
EBZ8050RH	390x490x496 (15.4x19.3x19.5)
Dry Weight kg (lbs)	11.5 (25.4)
Fuel Tank Capacity liter (fl. oz)	2.3 (77.7)
Engine Type	Air cooled 2-cycle gasoline engine
Piston Displacement cm ³ (cu. in)	71.9 (4.39)
Air Filter	2-stage fresh flow filter system
Carburetor (Diaphragm) valve type	Rotary
Ignition System	Digital ignition
Spark Plug	NGK CMR7H (Noise-proof)
Muffler	Spark arrester equipped
Operating Engine Speed rpm	2000 to 6700
Fuel Consumption liter/h (fl. oz/h)	1.9 (64.3)
Average Air Volume (w/std Pipe) cu. m/min (cfm)	19.4 (685)
Max. Air Volume (w/o Pipe) cu. m/min (cfm)	25.9 (915)
Max. Air Velocity m/sec (mph)	90 (201)
Emission Compliance Period hrs.	300
Noise Level (50 Feet ANSI B175. 2-2000) dB(A)	77

Specifications are subject to change without notice.

3. Warning labels on the machine

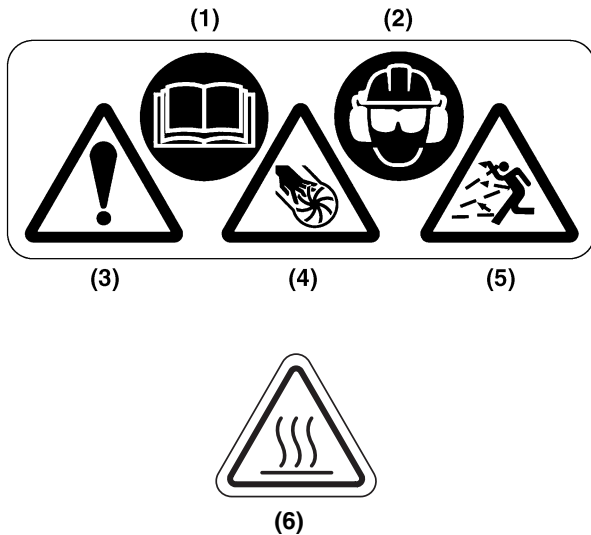

- (1) Read owner's manual before operating this machine.
- (2) Wear head, eye and ear protection.
- (3) Handling this machine improperly could result in accidents causing serious injury or death. Read this manual carefully and practice using the blower until you are fully acquainted with all operations and have learned to use it correctly.
- (4) Severing of fingers or hand by fan blade.
Do not open or remove safety guards or nets while engine is running.
- (5) Thrown or blown object.
Stay a safe distance from the machine.
- (6) Hot surface
Avoid contact the hot surface during and immediately operation.

⚠ IMPORTANT

If warning label peel off or become soiled and impossible to read, you should contact the dealer from which you purchased the product to order new labels and affix them in the required location(s).

⚠ WARNING

Never modify your machine.
We won't warrant the machine, if you use the remodeled machine or you don't observe the proper usage written in the manual.

4. Symbols on the machine



(a)

For safe operation and maintenance, symbols are carved in relief on the machine. According to these indications, please be careful not to make a mistake.

(a) The port to refuel the "MIX GASOLINE"
Position: FUEL TANK CAP



(b)

(b) The direction to close the choke
Position: INTAKE CUP



(c)

(c) The direction to open the choke
Position: INTAKE CUP

■ EMISSION CONTROL

An emission control label is located on the machine.

EMISSION CONTROL INFORMATION
 THIS ENGINE MEETS U.S. EPA AND CALIFORNIA EXH/EVP REGS FOR 2009*1 S.O.R.E.
 ENGINE FAMILY : 9HQZS.0725PQ*2 DISPL.: 72cc
 EMISSION CONTROL SYSTEM : EXH;EM/EVP;SP*3
COMPLIANCE PERIOD : 300 HOURS
 REFER TO OPERATOR'S MANUAL FOR MAINTENANCE, SPECIFICATIONS AND ADJUSTMENTS.
MANUFACTURED:
RedMax® USE JASO FD OR ISO L-EGD GRADE 50:1 OIL
 Husqvarna Zenoah Co., Ltd.

*1: The year will be changed every year of manufacturing.

*2: The initial number will be changed every year of manufacturing.

*3: SP : Sealed tank made of HDPE or PE.

▲ 5. For safe operation

▲ WARNING

- The blower is used for blowing away leaves and other debris on the ground. When operating the blower, the operator must stand with both feet firmly on the ground. Do not operate the blower while standing on a ladder or a stand.
- Under no circumstances may the design of the machine be modified without the permission of the manufacturer. Always use genuine accessories and parts. Non-authorized modifications and/or accessories or parts can result in serious personal injury or the death of the operator or others.
- When planning your work schedule, allow plenty of time to rest. Limit the amount of time over which the product is to be used continuously to somewhere around 30 ~ 40 minutes per session. Also try to keep the total amount of work performed in a single day under 2 hours or less.



■ Basic safety rules

1. Never operate a blower when you are fatigued, ill, or upset, or under the influence of medication that may make you drowsy, or if you are under the influence of alcohol or drugs.
2. Wear the following protective equipments when operating the blower.
 - a: Approved ear protection to reduce the risk of hearing loss.
 - b: Approved (ANSI Z87.1.) eye protection and foot protection to reduce the risk of injury associated with thrown objects.
 - c: Face filter mask in dusty conditions to reduce the risk of injury associated with the inhalation of dust.
 - d: Wear sturdy rubber-soled shoes or shoes with some other form of anti-slip protection to help protect you against falling.
 - e: Wear thick anti-vibration gloves to reduce the risk of whitefinger disease.
 - f: Do not wear loose clothing, scarves, neck chains, unconfined long hair, and like to reduce the risk of injury associated with objects being drawn into air intake and rotating parts.



Personal protective equipment cannot eliminate the risk of injury but it will reduce the degree of injury.

3. The ignition system of your unit produces an electromagnetic field of a very low intensity. This field may interfere with some pacemakers. To reduce the risk of serious or fatal injury, persons with pacemaker should consult their physician and the pacemaker manufacturer before operating this tool.
4. Do not allow other persons to be near the blower when starting. Keep bystanders and animals out of the work area. Children, pets and bystanders should be a minimum of 50 feet (15 meters) away when you operate the blower.
5. Avoid using the blower where stable footing and balance are not assured.
6. All blower service, other than the items listed in the Owner's Manual, should be performed by competent service personnel. (E.g., if improper service to the blower fan and muffler could cause a hazardous failure.)
7. Always shut off the engine before setting it down.
8. Operate the blower only in well ventilated areas. Never start or run the engine inside a closed room or building and potentially explosive atmosphere. Exhaust fumes contain dangerous carbon monoxide.
9. Never to touch the spark plug or plug cord while the engine is in operation. Doing so may result in being subjected to an electrical shock.
10. Never to touch the muffler, spark plug, other metallic parts of the engine or engine cover while the engine is in operation or immediately after shutting down the engine. These metallic parts and engine cover reach high temperatures during operation and doing so could result in serious burns.
11. To reduce the risk of injury associated with contacting rotating parts, stop the engine before installing or removing attachments. Do not operate without net in place. Always disconnect the spark plug before performing maintenance or accessing movable parts.

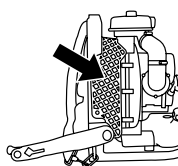

■ Before use

1. Each time before starting the engine, inspect the entire unit to see if every part is in good order and is securely tightened in place. If any damage is found in the fuel line, the exhaust line, or the ignition wiring, do not use the blower until it has been repaired.

▲ 5. For safe operation

▲ WARNING

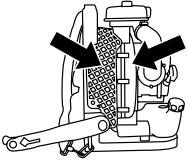

2. Before starting operation, always make sure to check if any obstacles are left inside the volute case and net. The obstacles may cause damage on fan and volute case and serious injury.

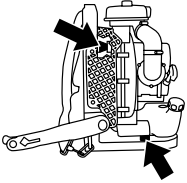

3. Check to see if the shock-absorbing rubber mount has become cracked or otherwise damaged. Note that failing to replace this rubber mount when it has become cracked or damaged may cause the engine to come loose from its frame during use, thus resulting in possible serious bodily injury. If cracked, be sure to replace without delay.



4. Check the work area that the blower will be used in and remove or cover all valuables that may be damaged by the air blast or thrown debris.

■ Using the product

1. To reduce the risk of injury associated with thrown objects.
 - a: Watch out for children, pets, open windows or freshly washed cars, and blow debris safely away.
 - b: Use the full blower nozzle extension so the air stream can work close to the ground.
 - c: Do not allow bystanders in work area.
 - d: Do not point the blower tube in the direction of people or pets.
 - e: Always check to be sure that no debris has been blown onto someone else's property.
 - f: Pay attention to the direction of the wind, do not work against the wind.
 - g: Never point a blower tube toward an open flame to avoid the possibility of igniting the unit, causing injury to yourself or damage to surroundings.
2. To minimize blowing time.
 - a: Use rakes and brooms to loosen debris before blowing.
 - b: In dusty conditions, slightly dampen surfaces.
 - c: Conserve water by using power blowers instead of hoses for many lawn and garden applications, including areas such as gutters, screens, patios, grills, porches and gardens.
3. If you detect abnormal vibration or noise during operation, promptly stop the blower and check whether something has broken.



If a breakdown has occurred, do not operate the blower until the problem is fixed.

4. After using blowers and other equipment, CLEAN UP! Dispose of debris in trash receptacles.

■ Transport

1. Drain the fuel from the fuel tank before transporting or storing the blower.
2. Secure the unit carefully to prevent movement when it is transported.
3. A unit that receives a strong shock during transport and unloading may malfunction.

■ Fuel safety

1. Always use caution when handling fuel. It is highly flammable. Wipe up all spills and then move the blower at least 10 feet (3 meters) from the fueling point before starting the engine.
2. Eliminate all sources of sparks or flame (i.e. smoking, open flames, or work that can cause sparks) in the areas where fuel is mixed, poured, or stored.
3. Do not smoke while handling fuel or while operating the blower.
4. Do not refuel a hot engine.
5. Do not refuel a running engine.
6. Keep the handles dry, clean and free of oil or fuel mixture.
7. Always store fuel in an approved container designed for that purpose.

■ Storage

1. Always store the blower and fuel so that there is no risk of leakages or fumes coming into contact with sparks or naked flames from electrical equipment, electric motors, relays/switches, boilers and the like.
2. For longer period of storage, the fuel tank should be emptied.
3. When storing the blower, choose a space indoors free from moisture and out of the reach of children.

■ Avoid noise problem

ⓘ IMPORTANT

Check and follow the local regulations as to sound level and hours of operations for blower.

1. Operate power equipment only at reasonable hours not early in the morning or late at night when people might be disturbed. Comply with times listed in local

▲ 5. For safe operation

- ordinances.
2. To reduce sound levels, limit the number of pieces of equipment used at any one time.
 3. Operate power blowers at the lowest possible throttle speed to do the job.
 4. Check your equipment before operation, especially the muffler, air intakes and air filters.

■ For protecting your body from vibration

▲ WARNING

Prolonged use of a blower, exposing the operator to vibrations and cold may produce whitefinger disease (Raynaud's phenomenon), which symptoms are tingling and burning sensations followed by loss of color and numbness in the fingers.

All factors which contribute to whitefinger disease are not known, but cold weather, smoking diseases or physical conditions as well as long periods of exposure to vibration are mentioned as factors.

In order to reduce the risk of whitefinger disease, the following precautions are strongly recommended.

- a: Keep your body warm. Never use blower during rains.
- b: Wear thick anti-vibration gloves.
- c: Take more than 5 minutes of break in warm place frequently.
- d: Maintain a firm grip at all times, but do not squeeze the handles with constant, excessive pressures.
- e: If you feel discomfort, redness and swelling of your fingers or any other part of your body, see a doctor before getting worse.

■ Maintenance

1. In order to maintain your product in proper working order, perform the maintenance and checking operations described in the manual at regular intervals.
2. Always be sure to turn off the engine and disconnect the spark plug before performing any maintenance or checking procedures.

▲ WARNING

The metallic parts and engine cover reach high temperatures immediately after stopping the engine.

3. Examine the blower at intervals for loose

fasteners and rusted or damaged parts.

Use special care around the fuel line, the muffler, and the ignition wiring.

4. When replacing the any other part, or any lubricant, always be sure to use only RedMax products or products which have been certified by RedMax for use with the RedMax product.
5. In the event that any part must be replaced or any maintenance or repair work not described in this manual must be performed, please contact a representative from the store nearest RedMax authorized servicing dealer for assistance.
6. Do not use any accessory or attachment other than those bearing the RedMax mark and recommended for the unit.
7. Under no circumstances should you ever take apart the product or alter it in any way. Doing so might result in the product becoming damaged during operation or the product becoming unable to operate properly.

■ Disposal

When disposing your machine, fuel or oil for the machine, be sure to allow your local regulations.



6. Set up

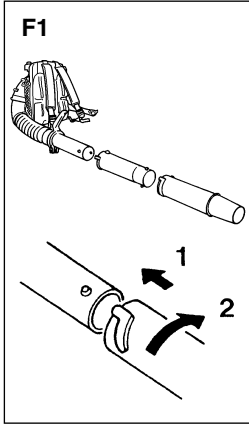

■ BLOWER TUBES

1. Connect the blower and swivel joint with flexible hose. Clamp both ends of the flexible hose securely with the hardware supplied with the unit.
2. Align the protrusion and the groove provided on the tube ends and twist the tube until connection is locked up.

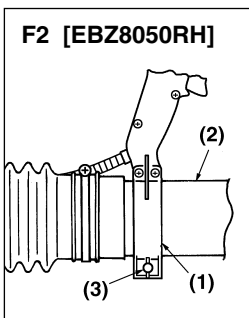
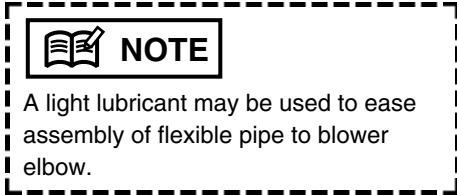

■ THROTTLE LEVER [EBZ8050RH]

- Set up the clamp to the swivel and tighten the screw on the clamp.

- (1) Clamp
- (2) Swivel
- (3) Screw

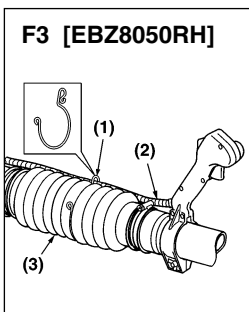

■ THROTTLE CABLE [EBZ8050RH]

- Use the clamp to fasten the colgate tube containing the throttle cable and the power cable to the hose.

- (1) Clamp
- (2) Cable
- (3) Hose

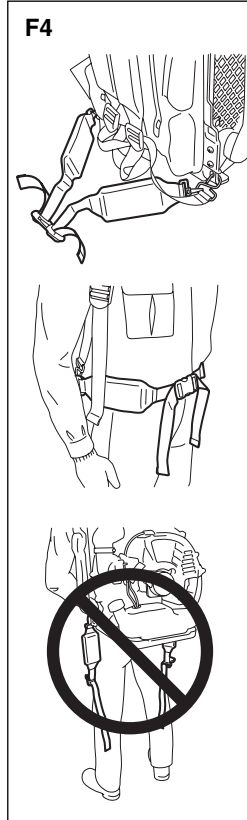

■ WAIST BELT (OPTIONAL ACCESSORY)

- The waist belt is attached to the hooks on the left and right sides of the frame.
- Be sure to always tighten the buckle in front of your body.



WARNING

- If you are not using a waist belt, be sure to remove it from the unit and store it.
- There is a risk that the belt will be caught, toppling the unit.
- There is a danger that the belt will be sucked into the fan.

7. Fuel

FUEL

⚠ WARNING

- Gasoline is very flammable. Avoid smoking or bringing any flame or sparks near fuel. Make sure to stop the engine and allow it cool before refueling the unit. Select outdoor bare ground for fueling and move at least 10 ft (3 m) away from the fueling point before starting the engine.



■ GASOLINE REQUIREMENTS

- All 2-Stroke RedMax Products are powered by RedMax Professional-Commercial Duty, Hi-Performance, Hi-RPM, Air Cooled 2-Stroke engines. RedMax – Hi-Performance 2-stroke engines produce higher HP outputs as compared to standard Home Owner Duty or Light Commercial Duty production engines offered by most manufacturers.
- Exhaust emission are controlled by the fundamental engine parameters and components (eq., carburation, ignition timing and port timing) without addition of any major hardware or the introduction of an inert material during combustion.
- The RedMax Engines are registered and certified with CARB (California Air Resources Board) and EPA (Environmental Protection Agency) to operate on CLEAN Mid-grade 89 octane or Premium, unleaded (lead-free) gasoline and RedMax Air-Cooled "Max Life", Synthetic blend Premium two-stroke engine oil mixed at 50:1 ratio.
- Unleaded gasoline is recommended to reduce the contamination of the air for the sake of your health and the environment.
- This Hi-Performance Air Cooled 2-stroke Engine requires the use of **Minimum** 89 Octane $\left[\frac{R+M}{2} \right]$ (Mid grade or Premium) clean gasoline. Gasoline may contain maximum of 10% Ethanol (grain alcohol) or up to 15% MTBE (Methyl tertiary-butyl ether). Gasoline containing Methanol (Wood Alcohol) is **NOT** approved.

📖 NOTE

- If octane rating of the Mid Grade gasoline in your area is lower than 89 Octane use Premium Unleaded Gasoline. The majority of all 2-stroke engine manufacturers in the USA and Canada recommend using gasoline with 89 Octane or higher.

⚠ WARNING

- Gasoline with an octane rating lower than 89 will greatly increase the engines operating temperature. Low octane gasoline will cause detonation (knock) resulting in piston seizures and major internal engine components damage.
- Poor quality gasolines or oils may damage sealing rings, fuel

lines or fuel tank of the engine.

📖 NOTE

- Failures caused by operating engines on gasoline with octane rating lower than 89 are not covered by the RedMax Two-Stroke engine warranty.

⚠ WARNING

- Alternative Fuels (Not Gasoline)**
Alternative fuels, such as E-15 (15% ethanol), E-20 (20% ethanol), E-85 (85% ethanol) are **NOT** classified as gasoline and are **NOT** approved for use in RedMax 2-stroke gasoline engines. Use of alternative fuels will cause major engine performance and durability problems such as: improper clutch engagements, overheating, vapor lock, power loss, lubrication deficiency, deterioration of fuel lines, gaskets and internal carburetor components, etc... Alternative fuels cause high moisture absorption into the fuel/oil mixture leading to oil and fuel separation.

■ OIL REQUIREMENTS

- Use only RedMax "Max Life", Synthetic blend Premium Air-Cooled two-stroke engine oil or oil certified to ISO-L-**EGD** (ISO/CD1378) standard AND one that is JASO-FD registered. RedMax Air-Cooled "Max Life", Synthetic blend Premium two stroke engine oil and ISO-L-**EGD** (ISO/CD1378) AND JASO-**FD** oils are fully compatible with gasoline's containing 10% Ethanol. RedMax Air-Cooled "Max Life", Synthetic blend Premium two stroke engine oil and ISO-L-**EGD** (ISO/CD1378) AND JASO-**FD** oils are **Universal** and should be mixed at 50:1 ratio for all 2 stroke air cooled engines sold in the past regardless of mixing ratios specified in those manuals.
- If the oil is registered with JASO, the JASO Logo with **FD** and registration number will be displayed on the container. The highest JASO rating is "FD", which equals the ISO-L-**EGD** rating. Lower ratings are "FC", "FB", and "FA".



- Engine problems due to inadequate lubrication caused by failure to use ISO-L-**EGD** certified and JASO **FD** registered oil such as "MaxLife", RedMax Synthetic blend Premium 2-stroke oil **WILL VOID THE REDMAX TWO-STROKE ENGINE WARRANTY.**

⚠ WARNING

- Do not use NMMA (National Marine Manufacturers Association), BIA (Boating Industry Association), and TCW (two cycle water cooled) oils designed for MoPeds or Outboard, water cooled Marine Engines. Do not use API (American Petroleum Institute), TC (Two Cycle) labeled oils. The API-TC

7. Fuel

test standard has been discontinued by API in 1995 and it no longer exists.

⚠ IMPORTANT

• Gasoline/Oil mixture Storage Recommendations

Store your gasoline or gasoline/oil mixture in a cool dry area in a tightly sealed approved container to limit the entry of moisture and additional air (oxygen). Moisture and air cause the development of varnish and gum, making the fuel stale. Stored gasoline and gasoline/oil mixture ages and loses its octane rating and volatility. Do not mix more gasoline/oil than you intend to use in 30 days, and 60 days when fuel stabilizer is added. RedMax Air-Cooled "Max Life" Synthetic blend Premium two-stroke engine oil "**Contains fuel stabilizer**" and will automatically extend your gasoline/oil mixture life up to 60 days.

■ HOW TO MIX FUEL

RECOMMENDED MIXING RATIO

GASOLINE 50 : OIL 1

(when using RedMax Air-Cooled "Max Life")

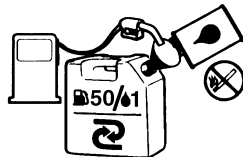

50:1 MIXING CHART

GASOLINE	gal.	1	2	3	4	5
2-CYCLE OIL	fl.oz	2.6	5.2	7.8	10.4	13

GASOLINE	liter	1	2	3	4	5
2-CYCLE OIL	ml	20	40	60	80	100

⚠ WARNING

• Pay attention to agitation.

1. Measure out the quantities of gasoline and oil to be mixed.
2. Put some of the gasoline into a clean, approved fuel container.
3. Pour in all of the oil and agitate well for 10seconds.
4. Pour in the rest of gasoline and agitate again for at least one minute. As some oils may be difficult to agitate depending on oil ingredients, sufficient agitation is necessary. Be careful that, if the agitation is insufficient, there is an increased danger of early piston seizure due to abnormally lean mixture.
5. Place a clear indication on the outside of the container to avoid mixing up with gasoline or other containers that dont contain oil.
6. Indicate the contents on outside of container for easy identification.

■ FUELING THE UNIT

1. Untwist and remove the fuel cap. Rest the cap on a clean surface.
2. Put fuel into the fuel tank to 80% of the full capacity.
3. Fasten the fuel cap securely and wipe up any fuel spillage around the unit.

⚠ WARNING

1. Select flat and bare ground for fueling.
2. Move at least 10 feet (3 meters) away from the fueling point before starting the engine.
3. Stop the engine before refueling the unit. At that time, be sure to sufficiently agitate the mixed gasoline in the container.

■ FOR YOUR ENGINE LIFE, AVOID

1. FUEL WITH NO OIL (RAW GASOLINE) – It will cause severe damage to the internal engine parts very quickly.
2. GASOHOL – It can cause deterioration of rubber and/or plastic parts and disruption of engine lubrication.
3. OIL FOR 4-CYCLE ENGINE USE – It can cause spark plug fouling, exhaust port blocking, or piston ring seizure.
4. **Mixed fuels which have been left unused for a period of one month or more** may clog the carburetor and result in the engine failing to operate properly.
5. In the case of storing the product for a long period of time, clean the fuel tank after rendering it empty. Next, Start the engine and run the carburetor dry residual fuel.
6. In the case of scrapping the used mixed oil container, scrap it only at an authorized depository site.

📖 NOTE

- As for details of quality assurance, read the description in the section Limited Warranty carefully. Moreover, normal wear and change in product with no functional influence are not covered by the warranty. Also, be careful that, if the usage in the instruction manual is not observed as to the mixed gasoline, type of oil or fuel to be used. described therein, it may not be covered by the warranty.

8. Operation

F5 [EBZ8050]

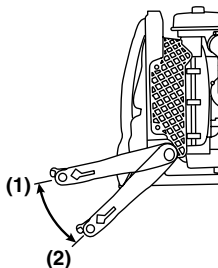
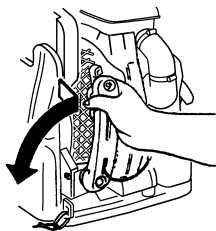

■ CONTROL ARM [EBZ8050] (F5)

- Hold the upper end of the control arm in hand and, while pulling it away from the unit, rotate arm forward (anti-clockwise as the arrow direction) until it clicks. (The first position)
And if you want, you can rotate arm more forward until it clicks. (The second position)
Choose the arm position according to your working condition.
- To fold the arm, reverse the order.

- (1) The First Position
(2) The Second Position

■ STARTING ENGINE

⚠ IMPORTANT

- Avoid operating the blower with the flexible tube and swivel joint disconnected. That will reduce the cooling air and the engine could be damaged by overheating.

F7

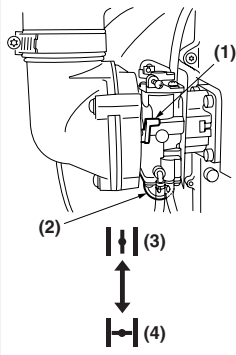

1. Push the primer bulb until fuel flows out in the clear tube. (F7)
2. When the engine is cool, close the choke. (F7)

- (1) Choke Lever
(2) Primer Bulb
(3) OPEN
(4) CLOSE

F8 [EBZ8050RH]

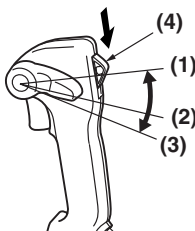

3. [EBZ8050RH]
Set the ignition switch to the start position. (F8)
4. Set the throttle lever in about 1/3 open position. (F8)(F9)

- (1) Full Throttle
(2) About 1/3 Open
(3) Idling
(4) Ignition Switch

F9 [EBZ8050]

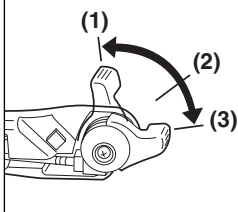

F10

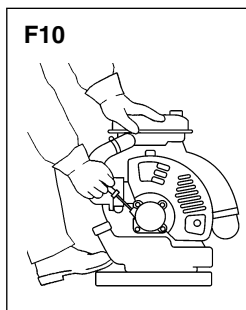

5. To start, hold the top of the blower firmly with your left hand. Pull the starter knob slowly until you feel it engage and then give it a vigorous strong pull. (F10)

⚠ IMPORTANT

- Avoid pulling the starter rope out to its full extent and allowing the starter rope to snap back. This will prevent premature damage to the starter.
- Do not let a person stand near the blower or the exhaust port.

6. Once the engine is running, gradually open the choke if it was set closed, and let the engine run at idle speed for a minute to warm it up.

📖 NOTE

When the engine fails to start after several attempts due to overchoking, open the choke and repeat pulling the rope.

8. Operation

F11



■ ADJUSTING THE SHOULDER STRAPS

Tightening:

- Pull on the end of the strap.

F12



Loosening:

- Pull up on the lower portion of the buckle with a finger and slide the end of the strap back up to the buckle.

F13



■ EMERGENCY REMOVAL

- In an emergency, pull up on the lower portion of both strap buckles to loosen the straps. Move yourself away from the unit.

F14

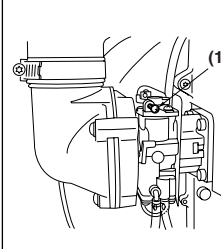

■ ADJUSTING IDLE SPEED (F14)

- The idling speed is set for 2000 rpm at the factory. If it is necessary to adjust the idle speed, use the adjustment screw on the top side of carburetor.

(1) Idling Adjustment Screw

F15 [EBZ8050]

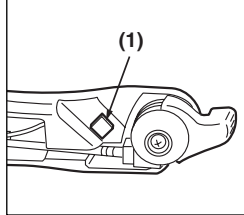

■ STOPPING ENGINE

[EBZ8050]

- Move the throttle lever to the idling position and press the stop switch (red button). The machine has the mechanism that once the stop button is pushed the plug won't give off sparks until the engine stops. (F15)

(1) Stop Switch

F16 [EBZ8050RH]

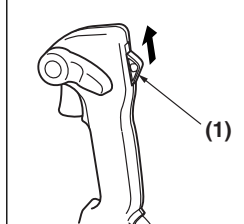

[EBZ8050RH]

- Move the throttle lever to the idling position and set the ignition switch to the stop position. (F16)

(1) Ignition Switch

F17

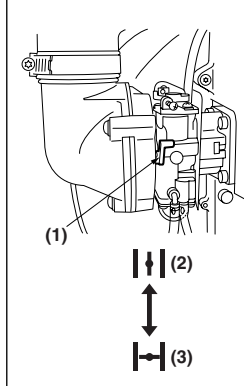

NOTE

If the engine won't stop when setting the ignition switch to the stop position, close the choke lever and stop the engine.

In this case, please repair the machine at your nearest servicing dealer. (F17)

(1) Choke Lever

(2) OPEN

(3) CLOSE

9. Maintenance

Maintenance, replacement, or repair of the emission control device and systems may be performed by any non-road engine repair establishment or individual.

System/Component		Procedure	Daily or Before use	Every 25 hours after	Every 50 hours after	Every 100 hours after
Air Filter	Prefilter	Inspect/Clean	✓			
	Paper Filter	Inspect/Replace			✓	
Fuel Leaks		Inspect/Replace	✓			
Fuel Filter		Inspect/Replace	✓	✓		
Fuel Line		Inspect/Clean	✓			
Spark Plug		Inspect/Clean		✓		
Muffler		Inspect/Clean	✓			
Muffler Spark Arrester		Inspect/Clean			✓	
Cooling System		Inspect/Clean	✓			
Screws/Nuts/Bolts		Tighten	✓			
Cylinder Exhaust Port		Inspect/Clean				✓

▲ WARNING

Make sure that the engine has stopped and is cool before performing any service to the blower. Contact with rotating blower fan or hot muffler may result in a personal injury.

■ AIR CLEANER

- Never operate the blower without an air filter or with a deformed or broken filter element because unfiltered dusty air will quickly ruin the engine.
- **Check the air cleaner before use.** A clogged air filter may increase fuel consumption while cutting down the engine power.
- Never clean a paper filter by striking it with or against another object. The filter may be damaged and resultant dust contamination can diminish engine performance.

CLEANING AIR FILTER:

1. Unscrew 2 knob bolts and remove the air cleaner cover. Then remove a prefilter mounted inside the air cleaner cover.

- (1) Knob Bolt
- (2) Prefilter
- (3) Inner Case
- (4) Paper Filter

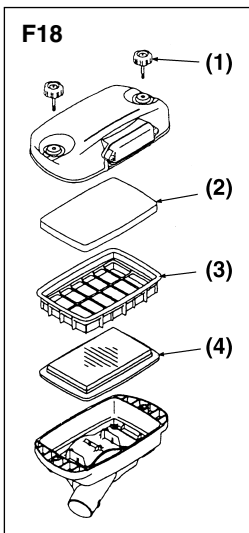

2. Wash the prefilter in fresh, non flammable cleaning solution (ex. warm soapy water) and then dry. (Clean the air filter once in a week.)
3. Exchange the paper filter element with new one in case it has been contaminated.

▲ WARNING

- **This prefilter is dry type.**
- **Never wash the prefilter in oleaginous cleaning solution.**
- **Do not clean a paper filter by striking it.**

■ FUEL FILTER

- A clogged fuel filter may cause poor acceleration of the engine. Check periodically to see if the filter is clogged with dirt. The filter can be taken out of the fueling port using a small wire hook. Disconnect the filter assembly from the fuel pipe and unhook the retainer to disassemble it. Clean the components with gasoline.

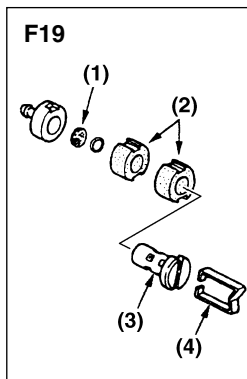

- (1) Screen
- (2) Element
- (3) Holder
- (4) Retainer

9. Maintenance

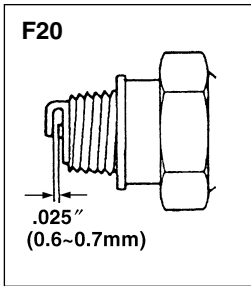

■ SPARK PLUG

- The spark plug may gather carbon deposits on its firing end with reasonable use. Remove and inspect the spark plug every 25 hours and clean the electrodes as necessary with a wire brush. The spark gap should be adjusted to .025 in (0.6~0.7mm).
- Plug manufacturers recommend replacing the plug twice a year to avoid unexpected plug failure in a job.

REPLACEMENT PLUG IS A NGK CMR7H.

⚠ IMPORTANT

- Note that using any spark plugs other than those designated may result in the engine failing to operate properly or in the engine becoming overheated and damaged.
- To install the spark plug, first turn the plug until it is finger tight, then tighten it a quarter turn more with a socket wrench.

■ MUFFLER

⚠ WARNING

- Inspect periodically, the muffler for loose fasteners, any damage or corrosion. If any sign of exhaust leakage is found, do not use the blower and have it repaired immediately.
- **Note that failing to do so may result in the engine catching on fire.**

⚠ IMPORTANT

- Before starting operation, always make sure to check if the muffler is properly held by three bolts (F21 (2)). (Fastening Torque : 8 to 12 N·m)
- Also make sure that the spark arrester and the diffuser are properly attached with four bolts (F21 (1)). (Fastening Torque : 2 to 3 N·m)
- Even if one of seven bolts is loose, it may result in engine catching on fire.

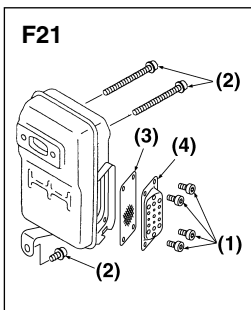

- (1) Bolt
(2) Bolt
(3) Spark arrester
(4) Diffuser

■ SPARK ARRESTER

- The muffler is equipped with a spark arrester to prevent red hot carbon from flying out of the exhaust outlet. Periodically inspect and clean as necessary with a wire brush. In the State of California it is required by law (Section 4442 of the California Pulic Resources Code) to equip a spark arrester when a gas powered tool is used in any forest covered, bush covered, or grass covered unimproved land.

■ PROCEDURES TO BE PERFORMED AFTER EVERY 100 HOURS OF USE

1. Remove the muffler, insert a screwdriver into the vent, and wipe away any carbon buildup. Wipe away any carbon buildup on the muffler exhaust vent and cylinder exhaust port at the same time.
2. Tighten all screws, bolts, and fittings.

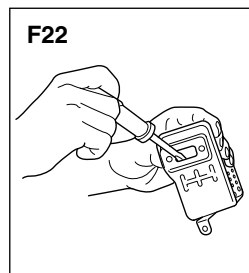

■ AIR INLET NET

⚠ IMPORTANT

- Blowing air is taken in from the air inlet net. When air flow has dropped down during operation, stop the engine and inspect the air inlet net for blocking by obstacles.
- Note that failure to remove any such obstacles may result in the engine becoming overheated and damaged.

(1) Net

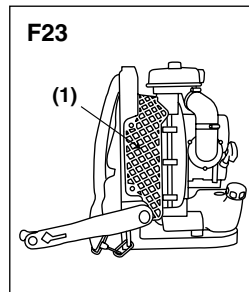

⚠ WARNING

Never use the blower without the net of the blower. Before each use, check that the net is attached in place and is free from any damage.

■ IGNITION COIL AIR GAP INSPECTION

- If the gap is out of standard or when installing the coil or rotor, adjust the air gap between the ignition coil and the iron core of the rotor.

Air Gap:
0.40mm (0.35 ~ 0.45mm)
0.016" (0.014 ~ 0.017")

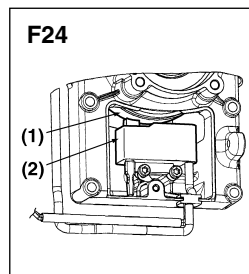

- (1) Rotor
(2) Ignition coil

9. Maintenance

■ SHOLDER STRAP

- If the shoulder strap is damaged it may break during use, thus causing the product to fall and resulting in personal injury. Follow the instructions below to replace the shoulder strap with new one.
- Take off the clip from the strap.
- Pass the end of the strap through the hanger.
- Return the clip to the strap.

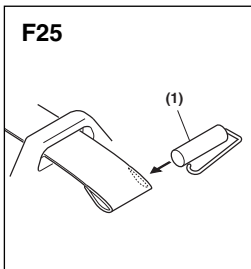

(1) Clip

⚠ IMPORTANT

Make sure that the thick round bar of the clip is in the strap. If it is attached in the wrong way, it leads to serious personal injury.

⚠ IMPORTANT

Do not apply liquid type screw lock glue on screws or bolts used to fix plastics components. Adherence of this type of glue may cause cracks on plastics and end up with the breakage.

10. Storage

BEFORE STORING THE BLOWER:

1. Drain a fuel tank and push the primer bulb until it becomes empty of fuel.
2. Remove the spark plug and drop a spoonful of 2-cycle oil into the cylinder. Crank the engine several times and install the spark plug.
3. Store unit in a dry, dust free place, out of the reach of children.

11. Disposal

- When disposing your machine, fuel or oil for the machine, be sure to allow your local regulations.

12. Troubleshooting guide

Case 1. Starting failure

CHECK	PROBABLE CAUSES	ACTION
fuel tank	→ incorrect fuel	→ drain it and with correct fuel
fuel filter	→ fuel filter is clogged	→ clean
carburetor adjustment screw	→ out of normal range	→ adjust to normal range
sparkling (no spark)	→ spark plug is fouled/wet	→ clean/dry
	→ plug gap is incorrect	→ correct (GAP: 0.6 – 0.7 mm)
spark plug	→ disconnected	→ retighten

Case 2. Engine starts but does not keep running/Hard re-starting.

CHECK	PROBABLE CAUSES	ACTION
fuel tank	→ incorrect fuel or staled fuel	→ drain it and with correct fuel
carburetor adjustment screw	→ out of normal range	→ adjust to normal range
muffler, cylinder (exhaust port)	→ carbon is built-up	→ wipe away
air cleaner	→ clogged with dust	→ wash
cylinder fin, fan cover	→ clogged with dust	→ clean

When your unit seems to need further service, please consult with our service shop in your area.

FEDERAL AND CALIFORNIA EMISSIONS CONTROL WARRANTY
STATEMENT YOUR WARRANTY RIGHTS AND OBLIGATIONS

The EPA (U.S. Environmental Protection Agency), CARB (California Air Resources Board), Environment Canada and RedMax are pleased to explain the emissions control system's warranty on your 2009 and later small off-road engine. In U.S. and Canada, new equipment that use small off-road engines must be designed, built, and equipped to meet the applicable Federal or Californian stringent anti-smog standards. RedMax must warrant the emissions control system on your small off-road engine for the period listed below provided there has been no abuse, neglect or improper maintenance of your equipment. Your emissions control system may include parts such as carburetor, ignition system, catalytic converter, fuel tank, filters and other associated components. Also, included may be hoses, belts, connectors, sensors, and other emission-related assemblies. Where a warrantable condition exists, RedMax will repair your small off-road engine at no cost to you including diagnosis, parts and labor.

MANUFACTURER'S WARRANTY COVERAGE

This emissions control system is warranted for two years or if the product qualifies for a longer warranty period resulting from the type of use, that period shall prevail. If any emissions-related part on your equipment is defective, the part will be repaired or replaced by RedMax.

OWNER'S WARRANTY RESPONSIBILITIES

As the small off-road engine owner, you are responsible for performance of the required maintenance listed in your Owner's Manual. RedMax recommends that you retain all receipts covering maintenance on your small off-road engine, but RedMax cannot deny warranty solely for the lack of receipts or your failure to ensure the performance of all scheduled maintenance. As the small off-road engine owner, you should however be aware that the RedMax may deny you warranty coverage if your small off-road engine or a part has failed due to abuse, neglect, or improper maintenance or unapproved modifications.

You are responsible for presenting your small off-road engine to a RedMax distribution center or service center as soon as the problem exists. The warranty repairs should be completed in a reasonable amount of time, not to exceed 30 days. If you have any questions regarding your warranty coverage, you should contact RedMax at 1-800-291-8251 or via e-mail at service@redmax.com.

WARRANTY COMMENCEMENT DATE

The warranty period begins on the date the engine or equipment is delivered to an ultimate purchaser.

LENGTH OF COVERAGE

RedMax warrants to the ultimate purchaser and each subsequent owner that the engine or equipment is designed, built, and equipped so as to conform with all applicable regulations adopted by EPA and CARB, and is free from defects in materials and workmanship that causes the failure of a warranted part for a period of two years.

WHAT IS COVERED

REPAIR OR REPLACEMENT OF PARTS Repair or replacement of any warranted part under the warranty must be performed at no charge to the owner at a warranty station. Warranty services or repairs will be provided at all RedMax distribution centers that are franchised to service the subject engines. Throughout the emissions warranty period of two years, RedMax must maintain a supply of warranted parts sufficient to meet the expected demand for such parts.

WARRANTY PERIOD Any warranted part that is scheduled for replacement as required in the maintenance schedule, is warranted for the period of time prior to the first scheduled replacement point for that part. If the part fails prior to the first scheduled replacement, the part will be repaired or replaced by RedMax at no cost. Any such part repaired or replaced under warranty is warranted for the remainder of the period prior to the first scheduled replacement point for the part. Any warranted part that is not scheduled for replacement as required in the maintenance schedule, is warranted for two years or if the product qualifies for a longer warranty period resulting from the type of use, that period shall prevail. If any such part fails during the period of warranty coverage, it will be repaired and replaced by RedMax at no cost. Any such part repaired or replaced under the

warranty is warranted for the remaining warranty period. Any warranted part that is scheduled only for regular inspection in the maintenance schedule will be warranted for a period of two years. A statement in such written instructions to the effect of "repair or replace as necessary" will not reduce the period of warranty coverage. Any such part repaired or replaced under warranty will be warranted for the remaining warranty period.

DIAGNOSIS The owner must not be charged for diagnostic labor that leads to the determination that a warranted part is in fact defective, provided that such diagnostic work is performed at a warranty station.

CONSEQUENTIAL DAMAGES RedMax is liable for damages to other engine components proximately caused by a failure under warranty of any warranted part.

EMISSION WARRANTY PARTS LIST

1. Air-induction system*
2. Fuel system*
3. Ignition system*
4. Fuel tank, cap and lines as applicable*

*some components only covered up to point specified by maintenance schedule

WHAT IS NOT COVERED

All failures caused by abuse, neglect or improper maintenance are not covered.

ADD-ON OR MODIFIED PARTS

Add-on or modified parts that are not exempted by CARB or EPA may not be used. The use of any non-exempted add-on or modified parts will be grounds for disallowing a warranty claim. RedMax will not be liable to warrant failures of warranted parts caused by the use of a non-exempted add-on or modified part.

HOW TO FILE A CLAIM

If you have any questions regarding your warranty rights and responsibilities, you should contact your nearest authorized servicing dealer or contact RedMax at 1-800-291-8251 or via e-mail at service@redmax.com.

WHERE TO GET WARRANTY SERVICE

Warranty services or repairs are provided through all RedMax authorized servicing dealers.

MAINTENANCE, REPLACEMENT AND REPAIR OF EMISSION-RELATED PARTS

Any replacement part may be used in the performance of any warranty maintenance or repairs and must be provided without charge to the owner. Such use will not reduce the warranty obligations of the manufacturer.

MAINTENANCE STATEMENT

The owner is responsible for the performance of all required maintenance, as defined in the operator's manual.