

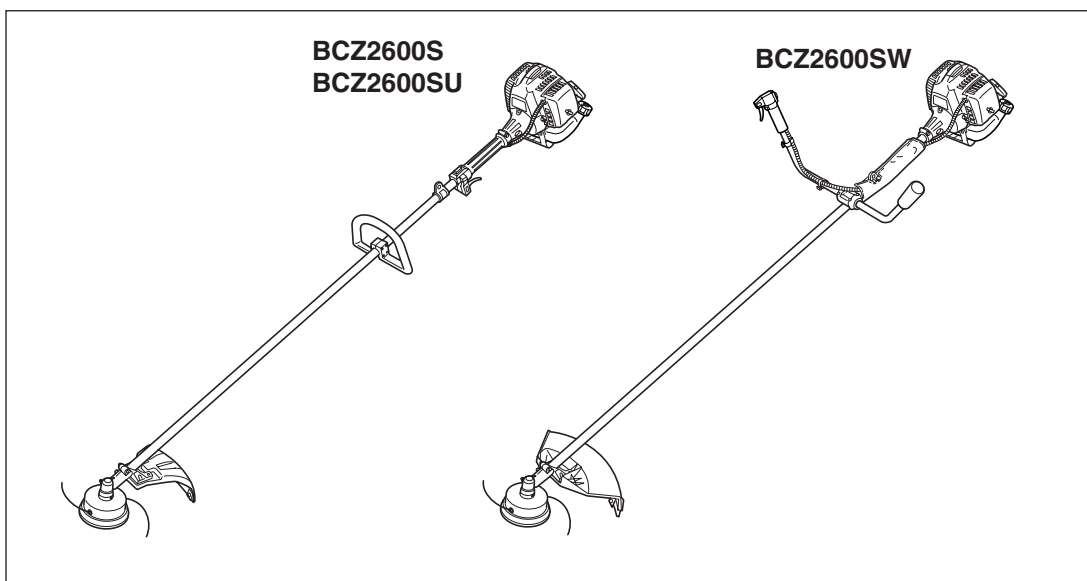

ILLUSTRATED PARTS LIST

BRUSHCUTTERS

BCZ2600S
BCZ2600SU
BCZ2600SW



! WARNING !
 The engine exhaust from this product contains chemicals known to the State of California to cause cancer, birth defects or other reproductive harm.

! WARNING !
 Before using our brushcutters, please read this manual carefully to understand the proper use of your unit.

APPLICABLE SERIAL NUMBERS :

BCZ2600S	DRIVE UNIT	300001	and up	ENGINE UNIT	300101	and up
BCZ2600SU	DRIVE UNIT	300001	and up	ENGINE UNIT	300101	and up
BCZ2600SW	DRIVE UNIT	300001	and up	ENGINE UNIT	300101	and up

13. Parts list

BRUSHCUTTERS

BCZ2600S
BCZ2600SU
BCZ2600SW

NOTE :

1. Use KOMATSU ZENOAH genuine parts as specified in the parts list for repair and/or replacement.
2. KOMATSU ZENOAH does not warrant the machines, which have been damaged by the use of any parts other than those specified by the company.
3. When placing parts orders for repair and/or replacement, check if the model name and the serial number are applicable to those specified in the parts list, then use parts number described in the parts list.
4. The contents described in the parts list may change due to improvement.
5. The parts for the machine shall be supplied seven (7) years after the machine is discontinued. [It is possible that some specific parts may be subject to change of their delivery term and list price within the limit of seven (7) years after the machine is discontinued. It is also possible that some parts may be available even after the limit of seven (7) years.]

APPLICABLE SERIAL NUMBERS :

Sep. 2003

BCZ2600S	DRIVE UNIT	300001	and up	ENGINE UNIT	300101	and up
BCZ2600SU	DRIVE UNIT	300001	and up	ENGINE UNIT	300101	and up
BCZ2600SW	DRIVE UNIT	300001	and up	ENGINE UNIT	300101	and up

13. Parts list

**Fig.1 DRIVE UNIT BCZ2600S (S/N 300001 and up)
BCZ2600SU (S/N 300001 and up)**

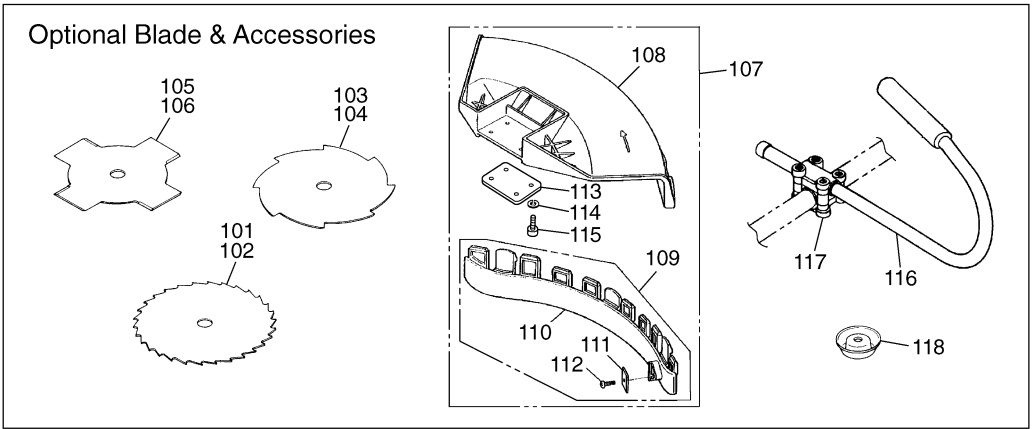
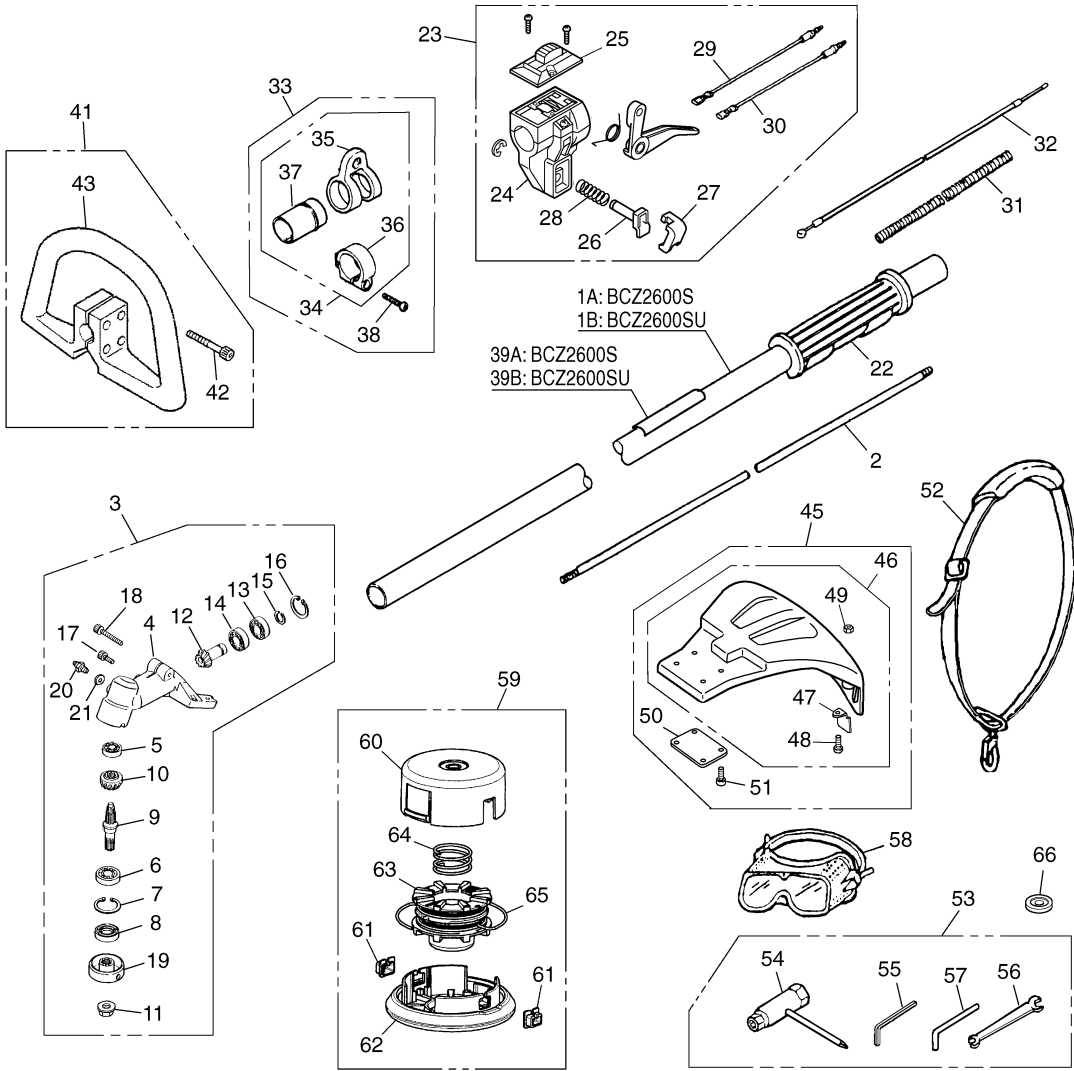

BCZ2600S (S/N 30001 and up)

Fig.1 DRIVE UNIT BCZ2600SU (S/N 30001 and up)

Key#	Description	Part Number	Q'ty	Key#	Description	Part Number	Q'ty
1A*	PIPE-COMP, 1500xø24xT1.7	T3002-12101	1	49	•• NUT	3320-15310	1
1B*	PIPE-COMP, 1500xø24xT1.5	T3064-12100	1	50	• PLATE	6489-24120	1
2	SHAFT, 1536xø7, spline 7T	3520-12213	1	51	• BOLT	01252-30514	4
3	GEARCASE-ASSY	T3002-13001	1	52	STRAP-ASSY	848B503610	1
4	• GEARCASE	6489-13110	1	53	TOOL-SET	T3002-91000	1
5	• BEARING	T3300-13521	1	54	• SOCKET	T3002-91310	1
6	• BEARING	T3403-13510	1	55	• WRENCH	09007-00425	1
7	• RING	04065-02612	1	56	• SPANNER	3540-91120	1
8	• SEAL	3565-13130	1	57	• BAR	3540-91110	1
9	• SHAFT	T3002-13210	1	58	GOGGLE	T3002-91190	1
10	• GEAR	6440-13220	1	59	TAP HEAD COMP.	PT104 Plus	1
11	• NUT, M10	T3002-13260	1	60	• CASE	T3189-15112	1
12	• PINION	T3002-13310	1	61	• EYELET	T3189-15191	2
13	• BEARING	T3300-13531	1	62	• COVER	T3189-15132	1
14	• BEARING	T3403-13530	1	63	• CORD HOLDER	T3189-15142	1
15	• RING	T3300-13330	1	64	• SPRING	T3189-15160	1
16	• RING	04065-02412	1	65	• CORD	T3189-15180	1
17	• BOLT	01252-30510	1	66	HOLDER (B)	6019-13250	1
18	• BOLT	3350-21320	1	* 1A, 39A for BCZ2600S 1B, 39B for BCZ2600SU			
19	• HOLDER (A)	6440-13242	1				
20	• FITTING, grease	3199-13350	1				
21	• WASHER	01641-20608	1				
22	GRIP	3577-32141	1				
23	LEVER-COMP	T3002-12202	1				
24	• LEVER	6110-14412	1				
25	• COVER-COMP	6110-14410020	1				
26	• SHAFT	6110-14410060	1				
27	• BUTTON	6110-14410090	1				
28	• SPRING	6110-14410080	1				
29	• CORD (A)	T3002-12220	1				
30	• CORD (B)	T3002-12230	1				
31	TUBE	T3002-12240	1				
32	CABLE	T3002-83100	1				
33	HANGER-ASSY	6420-17300	1				
34	• HANGER-COMP	6420-17400	1				
35	•• HANGER	9366-17110	1				
36	•• CLAMP	9366-17120	1				
37	•• SLEEVE	6420-17410	1				
38	• SCREW	0263-90525	1				
39A*	LABEL NAME & CAUTION	848B5090R1	1				
39B*	LABEL NAME & CAUTION	848B5290R1	1				
41	HANDLE-ASSY	T3339-14000	1				
42	• HANDLE	T3195-14102	1				
43	• SCREW	0263-90530	4				
45	GUARD-ASSY	T3002-24001	1				
46	• GUARD COMP	T3002-24101	1				
47	•• BLADE	T3002-24121	1				
48	•• SCREW	0263-90516	1				

OPTIONAL BLADE & ACCESSORIES

101	9" 22-tooth	SST229	1
102	9" 24-tooth	SST249	1
103	8" 8-tooth	SGB088	1
104	9" 8-tooth	SGB089	1
105	8" 4-tooth	SGB048	1
106	9" 4-tooth	SGB049	1
107	GUARD ASS'Y	6489-24000	1
108	• GUARD	6489-24110	1
109	• PLATE COMP.	6489-24200	1
110	•• PLATE	6489-24210	1
111	•• BLADE	6489-24220	1
112	•• SCREW	0277-10412	1
113	• PLATE	6489-24120	1
114	• WASHER	01601-20513	1
115	• BOLT	01252-30516	1
116	J-HANDLE	6367-14200	1
117	BRACKET	3583-14101	1
118	COVER	3540-13283	1

13. Parts list

Fig.2 DRIVE UNIT BCZ2600SW (S/N 30001 and up)

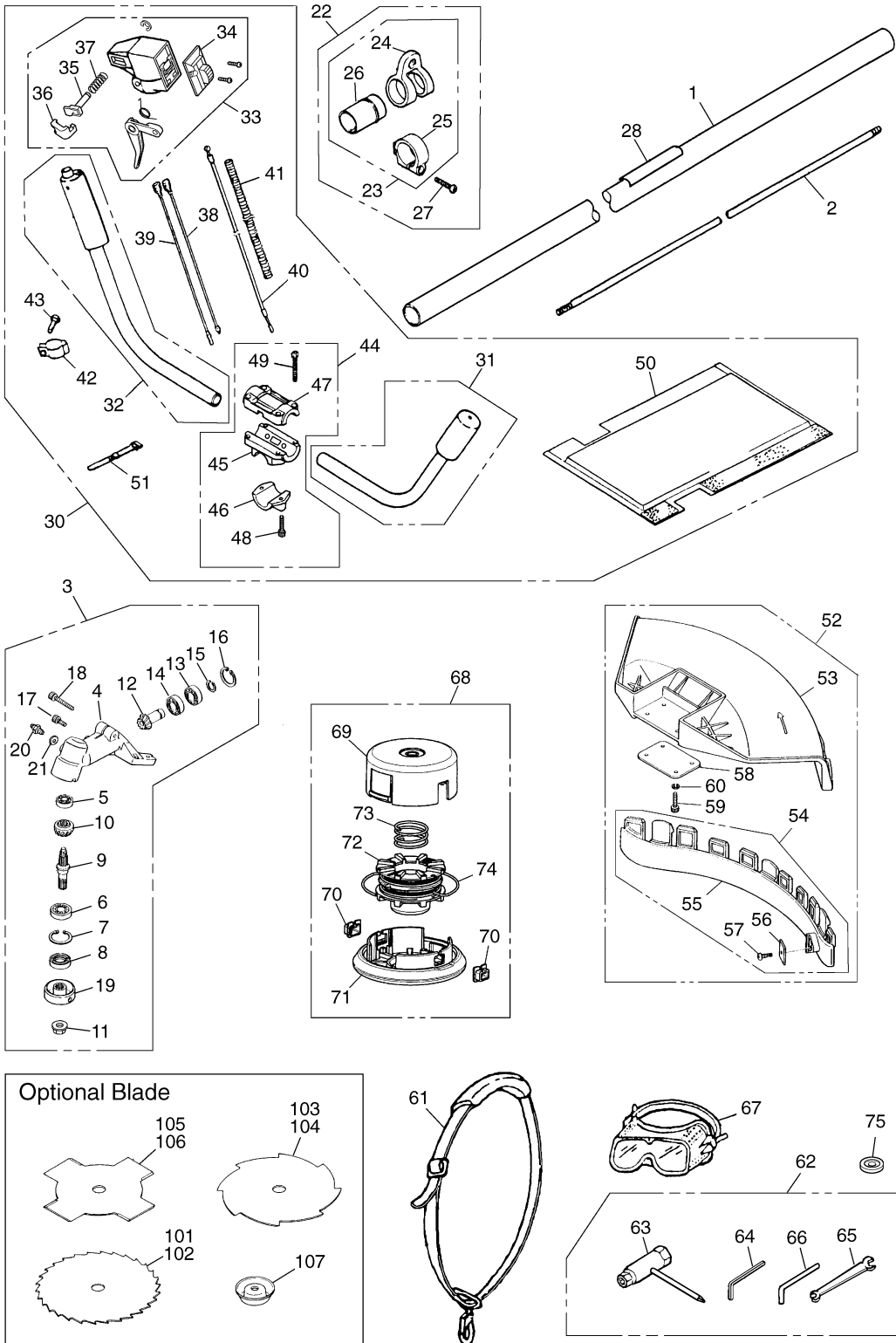

Fig.2 DRIVE UNIT BCZ2600SW (S/N 30001 and up)

Key#	Description	Part Number	Q'ty	Key#	Description	Part Number	Q'ty
1	PIPE-COMP, 1500xø24xT1.7	T3002-12101	1	51	• BAND	3540-93120	1
2	SHAFT, 1536xø7, spline 7T	3520-12213	1	52	GUARD ASS'Y	6489-24000	1
3	GEARCASE-ASSY	T3002-13001	1	53	• GUARD	6489-24110	1
4	• GEARCASE	6489-13110	1	54	• PLATE COMP.	6489-24200	1
5	• BEARING	T3300-13521	1	55	•• PLATE	6489-24210	1
6	• BEARING	T3403-13510	1	56	•• BLADE	6489-24220	1
7	• RING	04065-02612	1	57	•• SCREW	0277-10412	1
8	• SEAL	3565-13130	1	58	• PLATE	6489-24120	1
9	• SHAFT	T3002-13210	1	59	• BOLT	01252-30516	4
10	• GEAR	6440-13220	1	60	• WASHER	01601-20513	4
11	• NUT, M10	T3002-13260	1	61	STRAP-ASSY	848B503610	1
12	• PINION	T3002-13310	1	62	TOOL-SET	T3002-91000	1
13	• BEARING	T3300-13531	1	63	• SOCKET	T3002-91310	1
14	• BEARING	T3403-13530	1	64	• WRENCH	09007-00425	1
15	• RING	T3300-13330	1	65	• SPANNER	3540-91120	1
16	• RING	04065-02412	1	66	• BAR	3540-91110	1
17	• BOLT	01252-30510	1	67	GOGGLE	T3002-91190	1
18	• BOLT	3350-21320	1	68	TAP HEAD COMP.	PT104 Plus	1
19	• HOLDER (A)	6440-13242	1	69	• CASE	T3189-15112	1
20	• FITTING, grease	3199-13350	1	70	• EYELET	T3189-15191	2
21	• WASHER	01641-20608	1	71	• COVER	T3189-15132	1
22	HANGER-ASSY	6420-17300	1	72	• CORD HOLDER	T3189-15142	1
23	• HANGER-COMP	6420-17400	1	73	• SPRING	T3189-15160	1
24	•• HANGER	9366-17110	1	74	• CORD	T3189-15180	1
25	•• CLAMP	9366-17120	1	75	HOLDER (B)	6019-13250	1
26	•• SLEEVE	6420-17410	1				
27	• SCREW	0263-90525	1				
28	LABEL NAME & CAUTION	848B5190R1	1				
30	W-HANDLE KIT	T3002-95000	1				
31	• HANDLE-L-COMP	T3040-14200	1				
32	• HANDLE-R-COMP	T3002-95400	1				
33	• LEVER-ASSY	6234-14601	1				
34	•• COVER-COMP	6234-14601020	1				
35	•• SHAFT	6110-14410060	1				
36	•• BUTTON	6110-14410090	1				
37	•• SPRING	6110-14410080	1				
38	• CORD(A) BLACK	T3002-95710	1				
39	• CORD(B) RED	T3002-95720	1				
40	• CABLE-COMP	T3040-83100	1				
41	• TUBE	5512-73220	1				
42	• CLAMP	3260-14251	1				
43	• SCREW	0260-00516	1				
44	• BRACKET-ASSY	3583-14101	1				
45	•• BRACKET	3583-14111	1				
46	•• CAP-L	3583-14121	1				
47	•• CAP-U	3257-14192	1				
48	•• BOLT	01252-30522	2				
49	•• BOLT	01252-30525	4				
50	• PROTECTOR	4050-17110	1				

OPTIONAL BLADE			
Key#	Description	Part Number	Q'ty
101	9" 22-tooth	SST229	1
102	9" 24-tooth	SST249	1
103	8" 8-tooth	SGB088	1
104	9" 8-tooth	SGB089	1
105	8" 4-tooth	SGB048	1
106	9" 4-tooth	SGB049	1
107	COVER	3540-13283	1

13. Parts list

Fig.3 ENGINE UNIT

BC2600S (S/N 300101 and up)
BC2600SU (S/N 300101 and up)
BC2600SW (S/N 300101 and up)

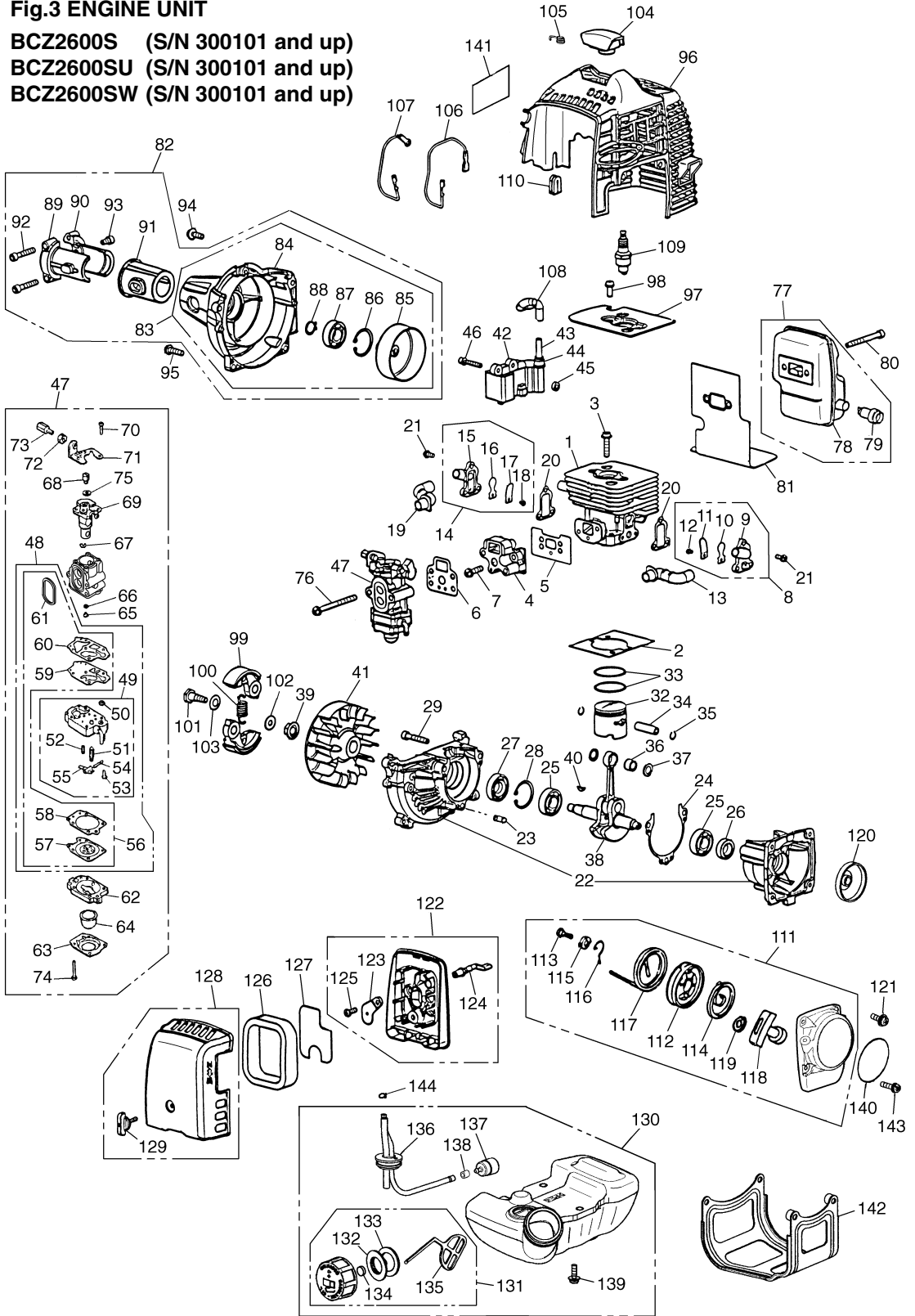

BCZ2600S (S/N 300101 and up)

BCZ2600SU (S/N 300101 and up)

Fig.3 ENGINE UNIT BCZ2600SW (S/N 300101 and up)

Key#	Description	Part Number	Q'ty	Key#	Description	Part Number	Q'ty
1	CYLINDER	4810-12111	1	73	• SCREW, adjuster	1918-81170	1
2	GASKET, base	4810-12210	1	74	• SCREW	1850-81530	4
3	BOLT, M5x22	1850-12130	2	75	• WASHER	5500-81160	1
4	INSULATOR	4810-13162	1	76	SCREW, M5x60	0263-90560	2
5	GASKET, insulator	4810-13120	1	77	MUFFLER ASS'Y	4810-15100	1
6	GASKET, carburetor	4810-13130	1	78	• MUFFLER	4810-15111	1
7	SCREW, M5x20	0263-90520	1	79	• ARRESTER	4810-15140	1
8	REEDVALVE (S)-A	848F301601	1	80	BOLT, M5x50	01252-30550	2
9	• VALVECASE (S)	848F3016A1	1	81	GASKET	T1501-15211	1
10	• REEDVALVE	4810-16120	1	82	COVER-A	4810-31001	1
11	• STOPPER	4810-16130	1	83	• COVER-C	4810-31101	1
12	• SCREW, M3x8	4810-16170	1	84	•• COVER, fan	4810-31111	1
13	PIRE AIR (S)	4810-16150	1	85	•• DRUM	848F3051A1	1
14	REEDVALVE (F)-A	848F301611	1	86	•• SNAPRING	04065-02812	1
15	• VALVECASE (F)	848F3016B1	1	87	•• BEARING	T1701-31150	1
16	• REEDVALVE	4810-16120	1	88	•• SNAP RING	04064-01210	1
17	• STOPPER	4810-16130	1	89	• BRACKET (A)	6470-31211	1
18	• SCREW, M3x8	4810-16170	1	90	• BRACKET (B)	6470-31221	1
19	PIPE AIR (F)	4810-16160	1	91	• CUSHION	6470-31230	1
20	GASKET, valve	4810-16140	2	92	• BOLT, M5x30	01252-30530	2
21	SCREW	4810-16180	6	93	• BOLT, M5x14	01252-30514	1
22	CRANKCASE-C	4810-21101	1	94	SCREW, M5x16	5500-85510	1
23	• PIN	2629-21130	3	95	SCREW, M5x20	0263-90520	4
24	GASKET	4810-21140	1	96	COVER, engine	4810-32111	1
25	BEARING	06030-06001	2	97	PLATE	T1501-12310	1
26	SEAL	4810-21210	1	98	SCREW, M5x10	0263-90510	2
27	SEAL	1850-21220	1	99	SHOE	4820-51110	2
28	SNAP RING	04065-02812	1	100	SPRING	4820-51220	1
29	BOLT, M5x30	01252-30530	3	101	SCREW	1140-51250	2
				102	WASHER	1140-51230	2
				103	WASHER	1140-51242	2
32	PISTON	4810-41110	1	104	CAP	4810-72111	1
33	RING	5910-41210	2	105	SPRING	1900-72120	1
34	PIN	1600-41310	1	106	CORD	4810-71240	1
35	RING	1260-41320	2	107	CORD, earth	4810-71250	1
36	BEARING	5500-41410	1	108	TUBE	T1512-71320	1
37	WASHER	1101-41340	2	109	PLUG, NGK CMR7A	4810-73110	1
38	CRANKSHAFT-O	4810-42000	1	110	GROMMET	4810-72120	1
39	NUT	1650-43230	1	111	RECOIL ASS'Y	4810-75100	1
40	KEY	1000-43240	1	112	• REEL	4500-75120	1
41	ROTOR	4810-71110	1	113	• SCREW	4500-75150	1
42	COIL-A	T1512-71200	1	114	• SPRING, spiral	1850-75130	1
43	• CORD	T1512-71220	1	115	• COLLAR	4500-75180	1
44	• CAP	2616-71320	1	116	• ARM	4500-75190	1
45	SPACER	1260-71261	2	117	• ROPE	4810-75160	1
46	BOLT, M4x22	4500-72150	2	118	• KNOB	3330-75421	1
47	CARBURETOR ASS'Y, WYA-1D	4810-81002	1	119	• PLATE, stopper	4810-75170	1
48	• REBUILD KIT	T1551-06030	1	120	PULLEY	4500-75210	1
49	•• BODY ASS'Y	T1551-81450	1	121	SCREW, M5x16	5500-85510	2
50	••• SCREEN	_____	—	122	BODY ASS'Y	4810-82100	1
51	••• VALVE	_____	—	123	• PLATE, choke	4810-82130	1
52	••• SPRING	_____	—	124	• LEVER, choke	5500-82140	1
53	••• SCREW	_____	—	125	• SCREW	2630-33610	1
54	••• PIN	_____	—	126	ELEMENT	4810-82170	1
55	••• LEVER	_____	—	127	SCREEN	4810-82180	1
56	•• GASKET KIT	4810-06021	1	128	COVER ASS'Y	4810-82200	1
57	••• DIAPHRAGM	_____	—	129	• KNOB	5500-82221	1
58	••• GASKET, diaphragm	_____	—	130	TANK ASS'Y	T1504-85002	1
59	••• DIAPHRAGM, pump	_____	—	131	• CAP ASS'Y	T1015-85202	1
60	••• GASKET, pump	_____	—	132	•• HOLDER-A	4500-85300	1
61	••• RING	4810-81130	1	133	•• PACKING	4500-85220	1
62	• BODY, purge	1850-81490	1	134	•• FILTER	5601-85260	1
63	• COVER, pump	1850-81520	1	135	•• STOPPER	4820-85260	1
64	• PUMP, priming	1751-81510	1	136	• PIPE COMP.	4810-85300	1
65	• JET #37.5	4810-81250	1	137	• FLTER ASS'Y	3302-85400	1
66	• O-RING	1751-81240	1	138	• COLLER	2841-31280	1
67	• RING	1751-81130	1	139	SCREW, M5x16	5500-85510	3
68	• SWIVEL	1881-81140	1	140	LABEL, recoil	_____	—
69	• VALVE ASS'Y	_____	—	141	LABEL, cover	4810-31132	1
70	• SCREW	1752-81110	2	142	GUARD	T1506-31910	1
71	• BRACKET	5500-81120	1	143	SCREW	0263-90525	2
72	• NUT, adjuster	1751-81180	1	144	CLIP	1950-86120	1