

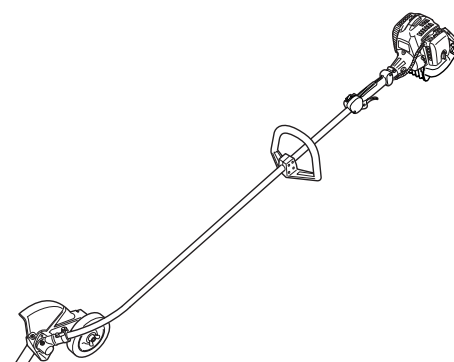

## OWNER'S/OPERATOR'S MANUAL

### STICK EDGERS

**HEZ2650F**



#### ⚠ WARNING ⚠

The engine exhaust from this product contains chemicals known to the State of California to cause cancer, birth defects or other reproductive harm.

#### ⚠ WARNING ⚠

Before using our products, please read this manual carefully to understand the proper use of your unit.

APPLICABLE SERIAL NUMBERS :

DRIVE UNIT 90800101 and up  
ENGINE UNIT 90800101 and up

**⚠ SAFETY FIRST**

Instructions contained in warnings within this manual marked with a **⚠** symbol concern critical points which must be taken into consideration to prevent possible serious bodily injury, and for this reason you are requested to read all such instructions carefully and follow them without fail.



■ **WARNINGS IN THE MANUAL**

**⚠ WARNING**

This mark indicates instructions which must be followed in order to prevent accidents which could lead to serious bodily injury or death.

**❗ IMPORTANT**

This mark indicates instructions which must be followed, or it leads to mechanical failure, breakdown, or damage.

**📖 NOTE**

This mark indicates hints or directions useful in the use of the product.

**⚠ WARNING**

1. Read this stick edger Owner/Operator Manual carefully. Be sure you understand how to operate this unit properly before you use it. Failure to do so could result in serious injury.
2. Be sure to keep this manual handy so that you may refer to it later whenever any questions arise. Also note that you are requested to contact the dealer from whom you purchased the product for assistance the event that you have any questions which cannot be answered herein.
3. Always be sure to include this manual when selling, lending, or otherwise transferring the ownership of this product.
4. Do not lend or rent your machine without the owner's manual.
5. Be sure that anyone using your unit understands the information contained in this manual.
6. Never let a child under 13 years old use the machine.

**Contents**

1. Parts location.....	3
2. Specifications .....	3
3. Warning labels on the machine .....	4
4. Symbols on the machine .....	4
5. For safe operation .....	5
6. Set up .....	9
7. Fuel.....	10
8. Operation.....	12
9. Maintenance .....	14
10. Storage .....	17
11. Disposal.....	17
12. Troubleshooting guide .....	17

## 1. Parts location

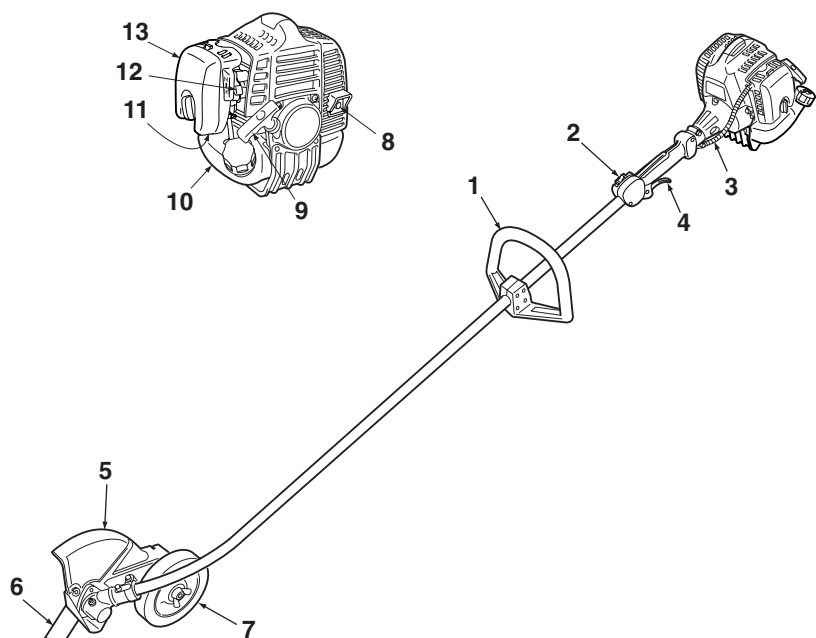

1. Loop handle
2. Stop switch
3. Throttle cable
4. Throttle lever
5. Blade guard
6. Blade
7. Wheel
8. Spark arrester
9. Starter knob
10. Fuel tank
11. Primer pump
12. Choke lever
13. Air cleaner cover

## 2. Specifications

### ■ HEZ2650F

Overall size(LxWxH) .....	72.8 (1850)x11.0 (280)x12.0 (305) in (mm)
Dry weight w/o acc. ....	14.0 (6.37) lbs (kg)
Engine Type.....	Air-cooled 2-stroke gasoline
Model.....	GZ25N
Displacement .....	1.6cu-in (25.4cm <sup>3</sup> )
Max. output .....	1.2Hp (0.9kW) at 7500 min <sup>-1</sup> (rpm)
Idle speed.....	3000 min <sup>-1</sup> (rpm)
Fuel .....	Mixture(Gasoline 50 : Oil 1)
	.....(when using RedMax genuine oil)
Carburetor .....	Walbro Diaphragm type
Spark plug .....	NGK CMR7H
Fuel tank capacity.....	22.0 fl.oz (0.65 l )
Transmission.....	Centrifugal clutch, Flexible driveshaft
Reduction ratio.....	1.25
Cutting head rotating direction.....	Clockwise (View against blade)
Durability period.....	300hrs.
Blade length .....	7.87 (200) in (mm)
Use for .....	Lawn edging

Specifications are subject to change without notice.

### 3. Warning labels on the machine

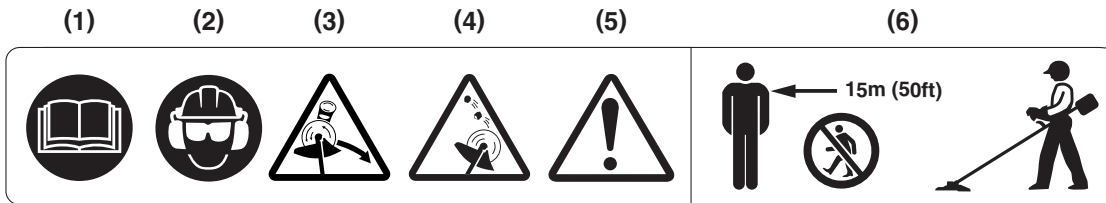

- (1) Read owner's manual before operating this machine.
- (2) Wear head, eye and ear protection.
- (3) Warning! Danger of kickback.
- (4) Beware of thrown objects.
- (5) Warning/Attention
- (6) Keep all children, bystanders and helpers 15 meters away from the machine.

#### ! IMPORTANT

If warning label peel off or become soiled and impossible to read, you should contact the dealer from which you purchased the product to order new labels and affix them in the required location(s).

#### ! WARNING

Never modify your machine.

We won't warrant the machine, if you use the remodeled machine or you don't observe the proper usage written in the manual.

### 4. Symbols on the machine



(a)

For safe operation and maintenance, symbols are carved in relief on the machine. According to these indications, please be careful not to take a mistake.

- (a) The port to refuel the "MIX GASOLINE"  
**Position:** FUEL TANK CAP



(b)

- (b) The direction to close the choke  
**Position:** AIR CLEANER COVER



(c)

- (c) The direction to open the choke  
**Position:** AIR CLEANER COVER

#### ■ EMISSION CONTROL

An emission control label is located on the engine.



\*1: The year will be changed every year of manufacturing.

\*2: The initial number will be changed every year of manufacturing.

\*3: SP : Sealed tank made of HDPE or PE.

## ▲ 5. For safe operation

### ▲ WARNING



- A brushcutter or trimmer can be dangerous if used incorrectly or carelessly, and can cause serious or fatal injury to the operator or others. It is extremely important that you read and understand the contents of this Owner's manual.
- Under no circumstances may the design of the machine be modified without the permission of the manufacturer. Always use genuine accessories and parts. Non-authorized modifications and/or accessories or parts can result in serious personal injury or the death of the operator or others.
- When planning your work schedule, allow plenty of time to rest. Limit the amount of time over which the product is to be used continuously to somewhere around 30 ~ 40 minutes per session. Also try to keep the total amount of work performed in a single day under 2 hours or less.
- If you don't observe the working time, or working manner (See p6), Repetitive Stress Injury(RSI) could occur. If you feel discomfort, redness and swelling of your fingers or any other part of your body, see a doctor before getting worse.



#### ■ Basic safety rules

1. Never operate the product when you are fatigued, ill, or upset, or under the influence of medication that may make you drowsy, or if you are under the influence of alcohol or drugs.
2. Never use the product;
  - a: When the ground is slippery or when you can't maintain a steady posture.
  - b: At night, at times of heavy fog, or at any other times when your field of vision might be limited and it would be difficult to gain a clear view of the working area.
  - c: During rain storms, during lightning storms, at times of strong or gale-force winds, or at any other times when weather conditions might make it unsafe to use the product.
3. Wear the following protective equipments when operating the product.
  - a: Approved helmet to reduce the risk of falling objects.

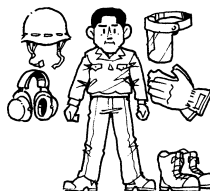

- b: Approved ear protection to reduce the risk of hearing loss.
- c: Approved (ANSI Z87.1.) eye protection and foot protection to reduce the risk of injury associated with thrown objects.
- d: Face filter mask in dusty conditions to reduce the risk of injury associated with the inhalation of dust.
- e: Wear sturdy rubber-soled shoes or shoes with some other form of anti-slip protection to help protect you against falling.
- f: Wear thick anti-vibration gloves to reduce the risk of whitefinger disease.
- g: Do not wear loose clothing, scarves, neck chains, unconfined long hair, and like to reduce the risk of injury associated with objects being drawn into air intake and rotating parts.

Personal protective equipment cannot eliminate the risk of injury but it will reduce the degree of injury.

4. The ignition system of your unit produces an electromagnetic field of a very low intensity. This field may interfere with some pacemakers. To reduce the risk of serious or fatal injury, persons with pacemaker should consult their physician and the pacemaker manufacturer before operating this tool.
5. The area within a perimeter of 50 feet (15 meters) of the person using the product should be considered a hazardous area into which no one should enter. If necessary yellow warning rope, warning signs should be placed around the perimeter of the area. When work is to be performed simultaneously by two or more persons, care should also be taken to constantly look around or otherwise check for the presence and locations of other people working so as to maintain a distance between each person sufficient to ensure safety.
6. Avoid using the product where stable footing and balance are not assured.
7. All product service, other than the items listed in the Owner's Manual, should be performed by competent service personnel.
8. Always shut off the engine before setting it down.
9. Start the engine only in well ventilated areas. Never start or run the engine inside a closed room or building and potentially explosive atmosphere. Exhaust fumes



## ▲ 5. For safe operation



- contain dangerous carbon monoxide.
- Never to touch the spark plug or plug cord while the engine is in operation. Doing so may result in being subjected to an electrical shock.
  - Never to touch the muffler, spark plug, other metallic parts of the engine or engine cover while the engine is in operation or immediately after shutting down the engine. These metallic parts and engine cover reach high temperatures during operation and doing so could result in serious burns.
  - To reduce the risk of injury associated with contacting rotating parts, stop the engine before installing or removing attachments. Always disconnect the spark plug before performing maintenance or accessing movable parts.

### ■ Before use

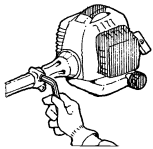

- Each time before starting the engine, inspect the entire unit to see if every part is in good order and is securely tightened in place. If any damage is found in the fuel line, the exhaust line, or the ignition wiring, do not use the product until it has been repaired.

### ▲ WARNING

- Before starting operation, always make sure that the cutting attachment and the debris guard are properly installed and securely fastened.**
- Check the condition of working area to avoid any accident by hitting hidden obstacles such as stumps, stones, cans, or broken grass.

### ⓘ IMPORTANT

Remove any obstacle before beginning work.

### ■ Starting the engine



- Keep bystanders and animals at least 50 feet (15 meters) away from the operating point. If you are approached, immediately stop the engine.
- The product is equipped with centrifugal clutch mechanism, so the cutting attachment could rotate as soon as the engine is started. When starting the engine, place the product onto the ground in a flat clear area and hold it firmly in place so as to ensure that neither the cutting part nor the throttle come into contact with any obstacle when the engine

starts.

### ▲ WARNING

**Make sure the throttle is at idle position. Never place the throttle into the high speed position or half throttle position (throttle lock position) when starting the engine.**

- After starting the engine, check to make sure that the cutting attachment stops rotating when the throttle is moved fully back to its original position (idle position). If it continues to rotate even after the throttle has been moved fully back, turn off the engine and take the unit to your authorized RedMax servicing dealer for repair.

### ■ Using the product

### ⓘ IMPORTANT

Cut only materials recommended by the manufacturer. And use only for tasks explained in the manual.

- Grip the handles firmly with both hands using your whole hand. Place your feet slightly apart (slightly further apart than the width of your shoulders) so that your weight is distributed evenly across both legs, and always be sure to maintain a steady, even posture while working.
- Keep cutting attachment below waist level.
- Maintain the speed of the engine at the level required to perform cutting work, and never raise the speed of the engine above the level necessary.
- If you detect abnormal vibration or noise during operation, promptly stop the product and check whether something has broken. If a breakdown has occurred, do not operate the product until the problem is fixed.
- Keep all parts of your body away from rotating cutting attachment.
- Guard against hazardous situations at all times. Warn adults to keep pets and children away from the area. Be careful if you are approached. Injury may result from flying debris.
- If someone calls out or otherwise interrupts you while working, always be sure to turn off the engine before turning around.
- After using the product and other equipment, CLEAN UP!

## **▲ 5. For safe operation**

### ■ Transport

1. Drain the fuel from the fuel tank before transporting or storing the product.
2. When hand-carrying the product, cover over the cutting part, lift up the product and carry it paying attention to the blade.
3. Secure the unit carefully to prevent movement when it is transported.
4. A unit that receives a strong shock during transport and unloading may malfunction.

### ■ Fuel safety

1. Always use caution when handling fuel. It is highly flammable. Wipe up all spills, screw the fuel cap back tightly, and then move the product at least 10 feet (3 meters) from the fueling point before starting the engine.
2. Eliminate all sources of sparks or flame (i.e. smoking, open flames, or work that can cause sparks) in the areas where fuel is mixed, poured, or stored.
3. Do not smoke while handling fuel or while operating the product.
4. Do not refuel a hot engine.
5. Do not refuel a running engine.
6. Keep the handles dry, clean and free of oil or fuel mixture.
7. Always store fuel in an approved container designed for that purpose.



### ■ Storage

1. Always store the product and fuel so that there is no risk of leakages or fumes coming into contact with sparks or naked flames from electrical equipment, electric motors, relays/switches, boilers and the like.
2. When storing the product, the fuel tank should be emptied.
3. When storing the product, choose a space indoors free from moisture and out of the reach of children.

### ■ Avoid noise problem

#### **! IMPORTANT**

Check and follow the local regulations as to sound level and hours of operations for the product.

1. Operate power equipment only at reasonable hours not early in the morning or late at night when people might be disturbed. Comply with times listed in local ordinances.
2. To reduce sound levels, limit the number of pieces of equipment used at any one time.

3. Operate the product at the lowest possible throttle speed to do the job.
4. Check your equipment before operation, especially the muffler, air intakes and air filters.

### ■ For protecting your body from vibration

#### **! WARNING**

**Prolonged use of the product, exposing the operator to vibrations and cold may produce whitefinger disease (Raynaud's phenomenon), which symptoms are tingling and burning sensations followed by loss of color and numbness in the fingers.**

**All factors which contribute to whitefinger disease are not known, but cold weather, smoking diseases or physical conditions as well as long periods of exposure to vibration are mentioned as factors. In order to reduce the risk of whitefinger disease, the following precautions are strongly recommended.**

- a: Keep your body warm. Never use the product during rains.
- b: Wear thick anti-vibration gloves.
- c: Take more than 5 minutes of break in warm place frequently.
- d: Maintain a firm grip at all times, but do not squeeze the handles with constant, excessive pressures.
- e: If you feel discomfort, redness and swelling of your fingers or any other part of your body, see a doctor before getting worse.

### ■ Maintenance

1. In order to maintain your product in proper working order, perform the maintenance and checking operations described in the manual at regular intervals.
2. Always be sure to turn off the engine and disconnect the spark plug before performing any maintenance or checking procedures.

#### **! WARNING**

**The metallic parts and engine cover reach high temperatures immediately after stopping the engine.**

3. Examine the product at intervals for loose fasteners and rusted or damaged parts. Use special care around the fuel line, the muffler, and the ignition wiring.
4. When replacing the any other part, or any

## **▲ 5. For safe operation**

---

lubricant, always be sure to use only RedMax products or products which have been certified by RedMax for use with the RedMax product.

5. In the event that any part must be replaced or any maintenance or repair work not described in this manual must be performed, please contact a representative from the store nearest RedMax authorized servicing dealer for assistance.
6. Do not use any accessory or attachment other than those bearing the RedMax mark and recommended for the unit.
7. Under no circumstances should you ever take apart the product or alter it in any way. Doing so might result in the product becoming damaged during operation or the product becoming unable to operate properly.

### **■ Disposal**

When disposing your machine, fuel or oil for the machine, be sure to allow your local regulations.



## 6. Set up

### ■ MOUNTING OTHER PARTS

1. Insert the driveshaft into the clutch drum, then attach the gearbox to the shaft tube as aligning the positioning holes and fasten the screw (A). Fasten the clamp bolt (B) firmly. (SE1)

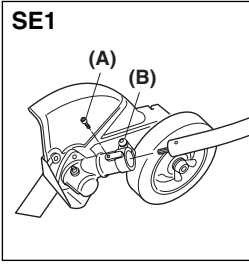

- (A) Screw
  - (B) Clamp bolt
- (B) Tightning Torque:  
52~69in-lbs (6~8N.m.)

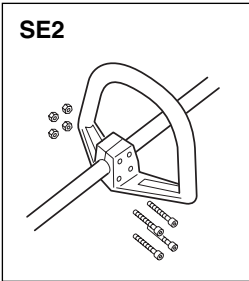

2. Install the handle to the shaft tube and clamp at a position best for your job. (SE2)

## 7. Fuel

### ■ FUEL

#### ▲ WARNING

- Gasoline is very flammable. Avoid smoking or bringing any flame or sparks near fuel. Make sure to stop the engine and allow it cool before refueling the unit. Select outdoor bare ground for fueling and move at least 10 ft (3 m) away from the fueling point before starting the engine.



### ■ GASOLINE REQUIREMENTS

- All 2-Stroke RedMax Products are powered by RedMax Professional-Commercial Duty, Hi-Performance, Hi-RPM, Air Cooled 2-Stroke engines. RedMax – Hi-Performance 2-stroke engines produce higher HP outputs as compared to standard Home Owner Duty or Light Commercial Duty production engines offered by most manufacturers.
- Exhaust emission are controlled by the fundamental engine parameters and components (eq., carburation, ignition timing and port timing) without addition of any major hardware or the introduction of an inert material during combustion.
- The RedMax Engines are registered and certified with CARB (California Air Resources Board) and EPA (Environmental Protection Agency) to operate on CLEAN Mid-grade 89 octane or Premium, unleaded (lead-free) gasoline and RedMax Air-Cooled "Max Life", Synthetic blend Premium two-stroke engine oil mixed at 50:1 ratio.
- Unleaded gasoline is recommended to reduce the contamination of the air for the sake of your health and the environment.
- This Hi-Performance Air Cooled 2-stroke Engine requires the use of **Minimum** 89 Octane  $\left[ \frac{R+M}{2} \right]$  (Mid grade or Premium) clean gasoline. Gasoline may contain maximum of 10% Ethanol (grain alcohol) or up to 15% MTBE (Methyl tertiary-butyl ether). Gasoline containing Methanol (Wood Alcohol) is **NOT** approved.

#### NOTE

- If octane rating of the Mid Grade gasoline in your area is lower than 89 Octane use Premium Unleaded Gasoline. The majority of all 2-stroke engine manufacturers in the USA and Canada recommend using gasoline with 89 Octane or higher.

#### ▲ WARNING

- Gasoline with an octane rating lower than 89 will greatly increase the engines operating temperature. Low octane gasoline will cause detonation (knock) resulting in piston seizures and major internal engine components damage.
- Poor quality gasolines or oils may damage sealing rings, fuel

lines or fuel tank of the engine.

#### NOTE

- Failures caused by operating engines on gasoline with octane rating lower than 89 are not covered by the RedMax Two-Stroke engine warranty.

#### ▲ WARNING

- Alternative Fuels (Not Gasoline)**  
Alternative fuels, such as E-15 (15% ethanol), E-20 (20% ethanol), E-85 (85% ethanol) are **NOT** classified as gasoline and are **NOT** approved for use in RedMax 2-stroke gasoline engines. Use of alternative fuels will cause major engine performance and durability problems such as: improper clutch engagements, overheating, vapor lock, power loss, lubrication deficiency, deterioration of fuel lines, gaskets and internal carburetor components, etc... Alternative fuels cause high moisture absorption into the fuel/oil mixture leading to oil and fuel separation.

### ■ OIL REQUIREMENTS

- Use only RedMax "Max Life", Synthetic blend Premium Air-Cooled two-stroke engine oil or oil certified to ISO-L-**EGD** (ISO/CD1378) standard AND one that is JASO-**FD** registered. RedMax Air-Cooled "Max Life", Synthetic blend Premium two stroke engine oil and ISO-L-**EGD** (ISO/CD1378) AND JASO-**FD** oils are fully compatible with gasoline's containing 10% Ethanol. RedMax Air-Cooled "Max Life", Synthetic blend Premium two stroke engine oil and ISO-L-**EGD** (ISO/CD1378) AND JASO-**FD** oils are **Universal** and should be mixed at 50:1 ratio for all 2 stroke air cooled engines sold in the past regardless of mixing ratios specified in those manuals.
- If the oil is registered with JASO, the JASO Logo with **FD** and registration number will be displayed on the container. The highest JASO rating is "FD", which equals the ISO-L-**EGD** rating. Lower ratings are "FC", "FB", and "FA".



- Engine problems due to inadequate lubrication caused by failure to use ISO-L-**EGD** certified and JASO **FD** registered oil such as "MaxLife", RedMax Synthetic blend Premium 2-stroke oil **WILL VOID THE REDMAX TWO-STROKE ENGINE WARRANTY.**

#### ▲ WARNING

- Do not use NMMA (National Marine Manufacturers Association), BIA (Boating Industry Association), and TCW (two cycle water cooled) oils designed for MoPeds or Outboard, water cooled Marine Engines. Do not use API (American Petroleum Institute), TC (Two Cycle) labeled oils. The API-TC

## 7. Fuel

test standard has been discontinued by API in 1995 and it no longer exists.

### IMPORTANT

#### Gasoline/Oil mixture Storage Recommendations

Store your gasoline or gasoline/oil mixture in a cool dry area in a tightly sealed approved container to limit the entry of moisture and additional air (oxygen). Moisture and air cause the development of varnish and gum, making the fuel stale. Stored gasoline and gasoline/oil mixture ages and loses its octane rating and volatility. Do not mix more gasoline/oil than you intend to use in 30 days, and 60 days when fuel stabilizer is added. RedMax Air-Cooled "Max Life" Synthetic blend Premium two-stroke engine oil "**Contains fuel stabilizer**" and will automatically extend your gasoline/oil mixture life up to 60 days.

#### HOW TO MIX FUEL

#### RECOMMENDED MIXING RATIO

#### GASOLINE 50 : OIL 1

(when using RedMax Air-Cooled "Max Life")

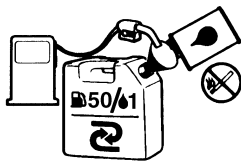

50:1 MIXING CHART

GASOLINE	gal.	1	2	3	4	5
2-CYCLE OIL	fl.oz	2.6	5.2	7.8	10.4	13

GASOLINE	liter	1	2	3	4	5
2-CYCLE OIL	ml	20	40	60	80	100

### WARNING

#### Pay attention to agitation.

1. Measure out the quantities of gasoline and oil to be mixed.
2. Put some of the gasoline into a clean, approved fuel container.
3. Pour in all of the oil and agitate well for 10seconds.
4. Pour in the rest of gasoline and agitate again for at least one minute. As some oils may be difficult to agitate depending on oil ingredients, sufficient agitation is necessary. Be careful that, if the agitation is insufficient, there is an increased danger of early piston seizure due to abnormally lean mixture.
5. Place a clear indication on the outside of the container to avoid mixing up with gasoline or other containers that dont contain oil.
6. Indicate the contents on outside of container for easy identification.

#### FUELING THE UNIT

1. Untwist and remove the fuel cap. Rest the cap on a clean surface.
2. Put fuel into the fuel tank to 80% of the full capacity.
3. Fasten the fuel cap securely and wipe up any fuel spillage around the unit.

### WARNING

1. Select flat and bare ground for fueling.
2. Move at least 10 feet (3 meters) away from the fueling point before starting the engine.
3. Stop the engine before refueling the unit. At that time, be sure to sufficiently agitate the mixed gasoline in the container.

#### FOR YOUR ENGINE LIFE, AVOID

1. FUEL WITH NO OIL (RAW GASOLINE) – It will cause severe damage to the internal engine parts very quickly.
2. GASOHOL – It can cause deterioration of rubber and/or plastic parts and disruption of engine lubrication.
3. OIL FOR 4-CYCLE ENGINE USE – It can cause spark plug fouling, exhaust port blocking, or piston ring seizure.
4. **Mixed fuels which have been left unused for a period of one month or more** may clog the carburetor and result in the engine failing to operate properly.
5. In the case of storing the product for a long period of time, clean the fuel tank after rendering it empty. Next, Start the engine and run the carburetor dry residual fuel.
6. In the case of scrapping the used mixed oil container, scrap it only at an authorized depository site.

### NOTE

- As for details of quality assurance, read the description in the section Limited Warranty carefully. Moreover, normal wear and change in product with no functional influence are not covered by the warranty. Also, be careful that, if the usage in the instruction manual is not observed as to the mixed gasoline, type of oil or fuel to be used. described therein, it may not be covered by the warranty.

## 8. Operation

The RedMax stick edgers are designed for edging lawn in gardens, parks, roadsides and so on.

Before starting the engine, take the operating position and adjust the handle position and the wheel height as necessary.

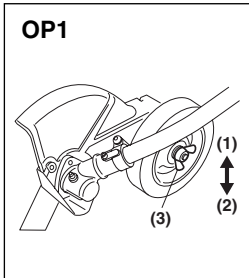

### ■ ADJUSTING WHEEL HEIGHT

1. Loosen the wing nut and change the wheel height to obtain desired cutting depth. (OP1)

- (1) Deep cut
- (2) Shallow cut
- (3) Wing nut

2. After adjusting the height, tighten the wing nut securely.

**Tightening Torque:**  
51~68in-lbs (6~8N.m.)



- Never adjust wheel height with the engine running.

### ■ STARTING ENGINE



**The cutting head will start rotating upon the engine starts.**

1. Rest the unit on a flat, firm place. Keep the cutting head off the ground and clear of surrounding objects as it will start rotating upon starting of the engine.

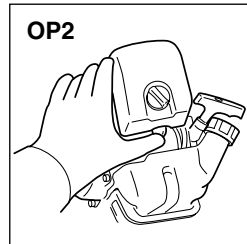

2. Push the primer pump several times until overflow fuel flows out in the clear tube. (OP2)

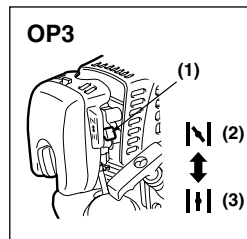

3. Move the choke lever to the closed position. (OP3)

- (1) choke lever
- (2) close
- (3) open

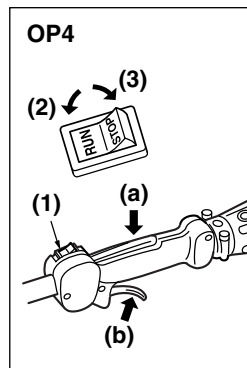

4. Set the stop switch to the "RUN" position. Place the unit on a flat, firm place. Keep the cutting head clear of everything around it. (OP4)

- (1) stop switch
- (2) RUN
- (3) STOP
- (a) lockout lever
- (b) throttle trigger

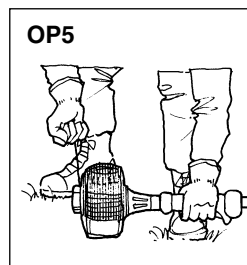

5. Firmly grasp (a) and (b) with left hand, pull the starter knob quickly until engine fires. (OP4,5)



- Avoid pulling the rope to its end or returning it by releasing the knob. Such actions can cause starter failures.

6. Move the choke lever downward to open the choke. And restart engine. (OP3)
7. Allow the engine to warm up for several minutes before starting operation.

## 8. Operation

### NOTE

1. When restarting the engine immediately after stopping it, leave the choke open.
2. Overchoking can make the engine hard to start due to excess fuel. When the engine failed to start after several attempts, open the choke and repeat pulling the rope, or remove the spark plug and dry it.

### ■ STOPPING ENGINE (OP4)

1. Release the throttle lever and run the engine for a half minute.
2. Shift the stop switch to the "STOP" position.

### ! IMPORTANT

- Except for an emergency, avoid stopping the engine while pulling the throttle lever.

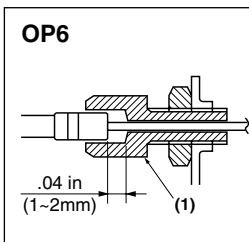

### ■ ADJUSTING THROTTLE CABLE

- The normal play is 1 or 2mm when measured at the carburetor side end. Readjust with the cable adjuster as required. (OP6)

#### (1) cable adjuster

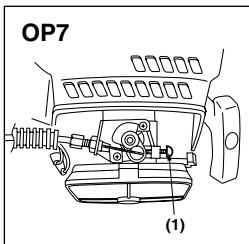

### ■ ADJUSTING IDLING SPEED (OP7)

1. When the engine tends stop frequently at idling mode, turn the adjusting screw clockwise.
2. When the cutting head keeps rotating after releasing the trigger, turn the adjusting screw counter-clockwise.

#### (1) idle adjusting screw

### NOTE

- Warm up the engine before adjusting the idling speed.

### ■ HOW TO USE

### ! WARNING

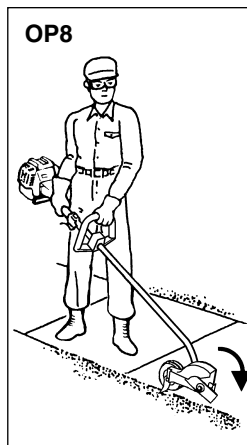

1. Always wear eye protection such as safety goggles. Never lean over the rotating cutting head. Rocks or other debris could be thrown into eyes and face and cause serious personal injury.
2. Keep the blade guard and the mud guard attached in place at all times when the unit is operated.
3. Before starting a job, check the area and remove all obstacles and objects that could be thrown by the blade.
4. Do not adjust the wheel height or try to remove anything entangled to the blade with the engine running.

1. Before starting the engine, adjust the wheel height for desired cutting depth (See page 12).
2. Before starting a job, plan your direction of travel so that you can always hold the edger on your right side and can walk on a hard surface as much as possible.
3. When starting to edge, maintain the engine speed at the level required to perform edging work, and slowly have the blade cut into the edge groove.

### NOTE

- Before edging, make sure the area is soft enough so the blade does not bog down.
- Do not move the edger into the work so fast that the engine or blade bogs down.
- Do not operate using starting throttle lock. It may cause unit uncontrolled, and clutch failure.
- Use care indirecting discharge to avoid bystanders, vehicles, glass, and the like.
- When the blade guard is clogged or blade stuck, stop the engine and clean it.

## 9. Maintenance

Maintenance, replacement, or repair of the emission control device and systems may be performed by any non-road engine repair establishment or individual.

### WARNING

- Always be sure to stop the engine before inspecting the stick edger for problems or performing maintenance.
- Never alter the stick edger or take the engine apart.
- When replacing parts, always be sure to use only RedMax products or products which have been certified by RedMax for use with the RedMax stick edger.

#### ■ BE SURE TO CHECK THE FOLLOWING BEFORE USING YOUR STICK EDGER

Item to be checked			Response
1	Edging mechanism	<ul style="list-style-type: none"> <li>• See if attachment is loose</li> <li>• Check if edges of blades are dull</li> </ul>	<ul style="list-style-type: none"> <li>• Tighten screws and bolts</li> <li>• Sharpen or replace blades</li> </ul>
2	Throttle	<ul style="list-style-type: none"> <li>• Stiff and difficult to move</li> </ul>	<ul style="list-style-type: none"> <li>• Repair or replace</li> </ul>
3	Throttle wire	<ul style="list-style-type: none"> <li>• Too loose, too tight</li> <li>• Stiff and difficult to move</li> </ul>	<ul style="list-style-type: none"> <li>• Adjust</li> <li>• Repair or replace</li> </ul>
4	Engine attachment	<ul style="list-style-type: none"> <li>• See if fittings are loose</li> </ul>	<ul style="list-style-type: none"> <li>• Tighten fittings</li> </ul>
5	Fuel tank	<ul style="list-style-type: none"> <li>• See if attachment is loose</li> <li>• See if fuel pipe is damaged</li> <li>• See if cap packing is damaged</li> </ul>	<ul style="list-style-type: none"> <li>• Tighten screws and bolts</li> <li>• Replace</li> <li>• Replace</li> </ul>
6	Muffler	<ul style="list-style-type: none"> <li>• See if attachment is loose</li> </ul>	<ul style="list-style-type: none"> <li>• Tighten screws and bolts</li> </ul>
7	Cutting blade	<ul style="list-style-type: none"> <li>• See if damaged or worn shorter than usable length</li> </ul>	<ul style="list-style-type: none"> <li>• Replace</li> </ul>

#### ■ MAINTENANCE CHART

	system/component	procedure	before use	every 25 hours after	every 50 hours after	every 100 hours after	note
ENGINE	fuel leaks, fuel spillage	wipe out	✓				
	fuel tank, air filter, fuel filter	inspect/clean	✓	✓			replace, if necessary
	idle adjusting screw	see ■ ADJUSTING IDLING SPEED (p.13)	✓				replace carburetor if necessary
	spark plug	clean and readjust plug gap			✓		GAP: .025in(0.6~0.7mm) replace, if necessary
	cylinder fins, intake air cooling vent	clean		✓			
	muffler, spark arrester, cylinder exhaust port	clean				✓	
SHAFT	throttle lever, ignition switch	check operation	✓				
	cutting parts	replace if something's wrong	✓				
	drive shaft	grease			✓		
	gear case	grease		✓			
	screws/nuts/bolts	tighten/replace	✓			✓	not adjusting screws
	cutting blade	inspect/replace	✓				replace, if necessary

## 9. Maintenance

### ⚠ WARNING

- Make sure that the engine has stopped and is cool before performing any service to the machine. Contact with moving cutting head or hot muffler may result in a personal injury.

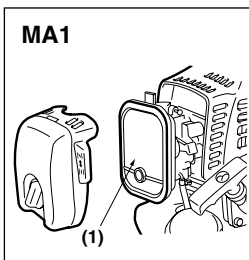

#### ■ AIR FILTER

- The air filter, if clogged, will reduce the engine performance. Check and clean the filter element. If the element is broken or clogged, replace with a new one. (MA1)

#### (1) air filter

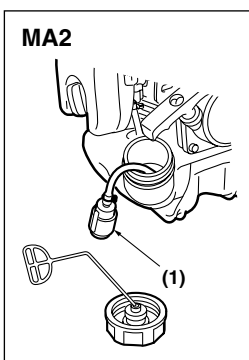

#### ■ FUEL FILTER

- When the engine runs short of fuel supply, check the fuel cap and the fuel filter for blockage. (MA2)

#### (1) fuel filter

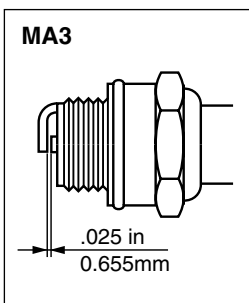

#### ■ SPARK PLUG

- Starting failure and mis-firing are often caused by a fouled spark plug. Clean the spark plug and check that the plug gap is in the correct range. For a replacement plug, use the correct type specified by RedMax. (MA3)

- **REPLACEMENT PLUG IS A NGK CMR7H.**

### ⚠ IMPORTANT

- Note that using any spark plug other than those designated may result in the engine failing to operate properly or in the engine becoming overheated and damaged.
- To install the spark plug, first turn the plug until it is finger tight, then tighten it a quarter turn more with a socket wrench.

#### **TIGHTENING TORQUE:**

**87~104 in-lbs  
(9.8~11.8 N.m.)**

#### ■ MUFFLER

### ⚠ WARNING

- Inspect periodically, the muffler for loose fasteners, any damage or corrosion. If any sign of exhaust leakage is found, stop using the machine and have it repaired immediately.
- **Note that failing to do so may result in the engine catching on fire.**

#### ■ SPARK ARRESTER

- The muffler is equipped with a spark arrester to prevent red hot carbon from flying out of the exhaust outlet. Periodically inspect and clean as necessary with a wire brush. In the State of California it is required by law (Section 4442 of the California Public Resources Code) to equip a spark arrester when a gas powered tool is used in any forest covered, brush covered, or grass covered unimproved land. (MA4)

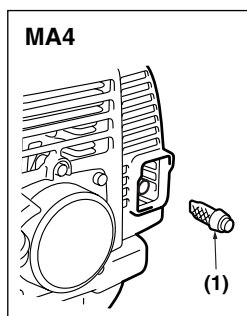

#### (1) spark arrester

#### ■ GEAR CASE

- The reduction gears are lubricated by multipurpose, lithium-based grease in the gear case. At every 25 hours of use, supply the gear case with new grease. (MA5)
- Remove the cutter holders before installing new grease to arrange for old grease to exit. (MA7)

### 📖 NOTE

- When removing and installing the holder(A), use care not to allow any dirt and dust entering in to the gear case. (MA7)

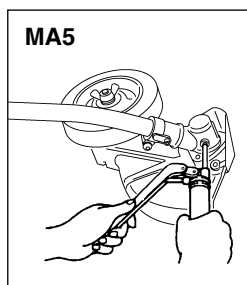

#### MA6

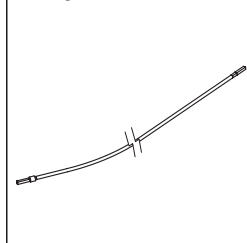

#### ■ DRIVE SHAFT (MA6)

- The drive shaft is lubricated by multipurpose lithium-based grease (NLGI No.2). Pull out the shaft from the pipe and supply new grease every 50 hours of use or more often depending on the job condition.

## 9. Maintenance

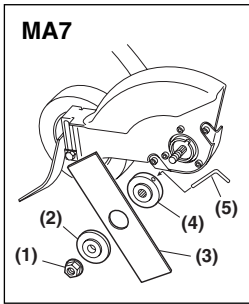

### ■ BLADE (MA7)

- Place the blade between holders (A) and (B) while locking the gear shaft by putting the bar, through the key holes on the holder(A) and the gearcase. Use the socket and the screwdriver to tighten the blade mounting bolt.

#### (1) Blade mounting nut (Left-handed)

##### **Tightning Torque:**

130~150in-lbs (15~20N.m.)

#### (2) Holder (B)

#### (3) Blade

#### (4) Holder (A)

#### (5) Bar

### ⚠ IMPORTANT

- Attention to the direction of the **holder (B)**.

### ■ INTAKE AIR COOLING VENT

### ⚠ WARNING

- Never touch the cylinder, muffler, or spark plugs with your bare hands immediately after stopping the engine. The engine can become very hot when in operation, and doing so could result in severe burns.**
- When checking the machine to make sure that it is okay before using it, check the area around the muffler and remove any wood chips or leaves which have attached themselves to the machine. Failing to do so could cause the muffler to become overheated, and that this in turn could cause the engine to catch on fire. Always make sure that the muffler is clean and free of wood chips, leaves, and other waste before use.**
- Check the intake air cooling vent and the area around the cylinder cooling fins after every 25 hours of use for blockage, and remove any waste which has attached itself to the machine. Note that it is necessary to remove the engine cover shown in (MA8) in order to be able to view the upper part of the cylinder.

### ⚠ IMPORTANT

- If waste gets stuck and causes blockage around the intake air cooling

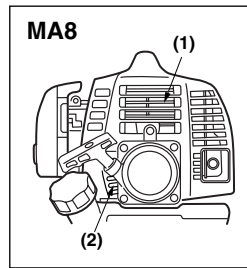

vent or between the cylinder fins, it may cause the engine to overheat, and that in turn may cause mechanical failure on the part of the machine. (MA8)

#### (1) cylinder

#### (2) intake air cooling vent (back)

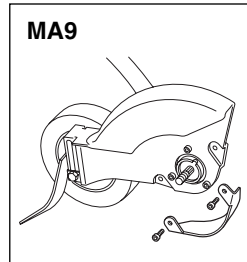

### ■ PROTECTOR

- When you replace protector, use new bolt (T3207-24130). (MA9)

##### **Tightning Torque:**

35~52in-lbs(4.0~6.0N.m.)

### ■ PROCEDURES TO BE PERFORMED AFTER EVERY 100 HOURS OF USE

- Remove the muffler, insert a screwdriver into the vent, and wipe away any carbon buildup. Wipe away any carbon buildup on the muffler exhaust vent and cylinder exhaust port at the same time.
- Tighten all screws, bolts, and fittings.
- Check to see if any oil or grease has worked its way in between the clutch lining and drum, and if it has wipe it away using oil-free, lead-free gasoline.

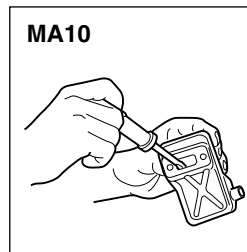



## 10. Storage

---

- Aged fuel is one of major causes of engine starting failure. Before storing the unit, empty the fuel tank and run the engine until it uses all the fuel left in the fuel line and the carburetor. Store the unit indoor taking necessary measures for rust prevention.

## 11. Disposal

---

- When disposing your machine, fuel or oil for the machine, be sure to allow your local regulations.

## 12. Troubleshooting guide

---

### Case 1. Starting failure

CHECK	PROBABLE CAUSES	ACTION
fuel tank	→ incorrect fuel	→ drain it and with correct fuel
fuel filter	→ fuel filter is clogged	→ clean
carburetor adjustment screw	→ out of normal range	→ adjust to normal range
sparkling (no spark)	→ spark plug is fouled/wet	→ clean/dry
	→ plug gap is incorrect	→ correct (GAP: 0.6 – 0.7 mm)
spark plug	→ disconnected	→ retighten

### Case 2. Engine starts but does not keep running/Hard re-starting.

CHECK	PROBABLE CAUSES	ACTION
fuel tank	→ incorrect fuel or staled fuel	→ drain it and with correct fuel
carburetor adjustment screw	→ out of normal range	→ adjust to normal range
muffler,cylinder (exhaust port)	→ carbon is built-up	→ wipe away
air cleaner	→ clogged with dust	→ replace
cylinder fin, fan cover	→ clogged with dust	→ clean

When your unit seems to need further service, please consult with our service shop in your area.

**FEDERAL AND CALIFORNIA EMISSIONS CONTROL WARRANTY**  
**STATEMENT YOUR WARRANTY RIGHTS AND OBLIGATIONS**

The EPA (U.S. Environmental Protection Agency), CARB (California Air Resources Board), Environment Canada and RedMax are pleased to explain the emissions control system's warranty on your 2009 and later small off-road engine. In U.S. and Canada, new equipment that use small off-road engines must be designed, built, and equipped to meet the applicable Federal or Californian stringent anti-smog standards. RedMax must warrant the emissions control system on your small off-road engine for the period listed below provided there has been no abuse, neglect or improper maintenance of your equipment. Your emissions control system may include parts such as carburetor, ignition system, catalytic converter, fuel tank, filters and other associated components. Also, included may be hoses, belts, connectors, sensors, and other emission-related assemblies. Where a warrantable condition exists, RedMax will repair your small off-road engine at no cost to you including diagnosis, parts and labor.

**MANUFACTURER'S WARRANTY COVERAGE**

This emissions control system is warranted for two years or if the product qualifies for a longer warranty period resulting from the type of use, that period shall prevail. If any emissions-related part on your equipment is defective, the part will be repaired or replaced by RedMax.

**OWNER'S WARRANTY RESPONSIBILITIES**

As the small off-road engine owner, you are responsible for performance of the required maintenance listed in your Owner's Manual. RedMax recommends that you retain all receipts covering maintenance on your small off-road engine, but RedMax cannot deny warranty solely for the lack of receipts or your failure to ensure the performance of all scheduled maintenance. As the small off-road engine owner, you should however be aware that the RedMax may deny you warranty coverage if your small off-road engine or a part has failed due to abuse, neglect, or improper maintenance or unapproved modifications.

You are responsible for presenting your small off-road engine to a RedMax distribution center or service center as soon as the problem exists. The warranty repairs should be completed in a reasonable amount of time, not to exceed 30 days. If you have any questions regarding your warranty coverage, you should contact RedMax at 1-800-291-8251 or via e-mail at [service@redmax.com](mailto:service@redmax.com).

**WARRANTY COMMENCEMENT DATE**

The warranty period begins on the date the engine or equipment is delivered to an ultimate purchaser.

**LENGTH OF COVERAGE**

RedMax warrants to the ultimate purchaser and each subsequent owner that the engine or equipment is designed, built, and equipped so as to conform with all applicable regulations adopted by EPA and CARB, and is free from defects in materials and workmanship that causes the failure of a warranted part for a period of two years.

**WHAT IS COVERED**

**REPAIR OR REPLACEMENT OF PARTS** Repair or replacement of any warranted part under the warranty must be performed at no charge to the owner at a warranty station. Warranty services or repairs will be provided at all RedMax distribution centers that are franchised to service the subject engines. Throughout the emissions warranty period of two years, RedMax must maintain a supply of warranted parts sufficient to meet the expected demand for such parts.

**WARRANTY PERIOD** Any warranted part that is scheduled for replacement as required in the maintenance schedule, is warranted for the period of time prior to the first scheduled replacement point for that part. If the part fails prior to the first scheduled replacement, the part will be repaired or replaced by RedMax at no cost. Any such part repaired or replaced under warranty is warranted for the remainder of the period prior to the first scheduled replacement point for the part. Any warranted part that is not scheduled for replacement as required in the maintenance schedule, is warranted for two years or if the product qualifies for a longer warranty period resulting from the type of use, that period shall prevail. If any such part fails during the period of warranty coverage, it will be repaired and replaced by RedMax at no cost. Any such part repaired or replaced under the

warranty is warranted for the remaining warranty period. Any warranted part that is scheduled only for regular inspection in the maintenance schedule will be warranted for a period of two years. A statement in such written instructions to the effect of "repair or replace as necessary" will not reduce the period of warranty coverage. Any such part repaired or replaced under warranty will be warranted for the remaining warranty period.

**DIAGNOSIS** The owner must not be charged for diagnostic labor that leads to the determination that a warranted part is in fact defective, provided that such diagnostic work is performed at a warranty station.

**CONSEQUENTIAL DAMAGES** RedMax is liable for damages to other engine components proximately caused by a failure under warranty of any warranted part.

#### **EMISSION WARRANTY PARTS LIST**

1. Air-induction system\*
  2. Fuel system\*
  3. Ignition system\*
  4. Fuel tank, cap and lines as applicable\*
- \*some components only covered up to point specified by maintenance schedule

#### **WHAT IS NOT COVERED**

All failures caused by abuse, neglect or improper maintenance are not covered.

#### **ADD-ON OR MODIFIED PARTS**

Add-on or modified parts that are not exempted by CARB or EPA may not be used. The use of any non-exempted add-on or modified parts will be grounds for disallowing a warranty claim. RedMax will not be liable to warrant failures of warranted parts caused by the use of a non-exempted add-on or modified part.

#### **HOW TO FILE A CLAIM**

If you have any questions regarding your warranty rights and responsibilities, you should contact your nearest authorized servicing dealer or contact RedMax at 1-800-291-8251 or via e-mail at [service@redmax.com](mailto:service@redmax.com).

#### **WHERE TO GET WARRANTY SERVICE**

Warranty services or repairs are provided through all RedMax authorized servicing dealers.

#### **MAINTENANCE, REPLACEMENT AND REPAIR OF EMISSION-RELATED PARTS**

Any replacement part may be used in the performance of any warranty maintenance or repairs and must be provided without charge to the owner. Such use will not reduce the warranty obligations of the manufacturer.

#### **MAINTENANCE STATEMENT**

The owner is responsible for the performance of all required maintenance, as defined in the operator's manual.