

EMISSIONS SERVICE BULLETIN

To: **All RedMax Distributors and Dealers**
 Subject: **Emission Carburetor: Low Speed Mixture Needle
 and Altitude Adjustment Procedures (Fixed Main Jet)**
 Emissions Carburetor: **Walbro-Model: WYA- 121 PART # 528062401**

PRODUCT MODEL	ENGINE SERIAL NUMBER
Brush-cutter: BCZ2650S / BCZ2660TS	From: All units listed with above carburetor model

The carburetors on the listed model have been factory preset to C.A.R.B. Tier III and E.P.A Phase II emissions regulations. The **idle-speed** adjustment is controlled by idle speed throttle valve screw. The Low-speed mixture needles has been preset and sealed to insure compliance with emission regulations. The **Low-speed Fuel mixture needle** adjustment controls the Fuel/ Air mixture at idle and mid-range engine speeds. The wide open throttle (WOT) speed operation is controlled by **Fixed Main Jet**. Extended operation above 4000 ft, or after carburetor rebuild, requires readjustment of idle screw and mixture needle to insure the engine continues to comply with C.A.R.B, and E.P.A, emission regulations.

1. REQUIRED TOOLS

Carburetor adjustment screw driver 2.5 mm flat tip, Limiter cap removal tool, Electronic digital tachometer with sensitivity capable to within 10 RPM increments, and One (1) Limiter cap.

WARNING!!! DANGER!!!

Always operate unit in a well ventilated and clear work area. Keep hands clear of moving, rotating, cutting attachment, or components during adjustment otherwise serious bodily injury may occur.

2. PRE - ADJUSTMENT CHECK LIST

IMPORTANT: Before performing carburetor adjustment, the following areas must be inspected and in good working order.

- Correct spark plug set to specified gap must be used.
Spark Plug: NGK-CMR7H Gap: 0.026 inch (0.65 mm)
- Standard nylon head must be installed with **7 inches (180 mm)** of line exposed on **both sides**.
- The air filter must be clean and properly installed.
- The carburetor and carburetor insulator block screws must be tight.
- The fuel filter must be clean and properly installed.
- The muffler spark arrestor screen and exhaust port must be clear of carbon.
- The fuel must be fresh (> 89 Octane or higher: RON+MON/ 2) and properly mixed at 50:1 ratio with RedMax or (ISO-L-EGD/ JASO FD) registered 2-stroke oil.

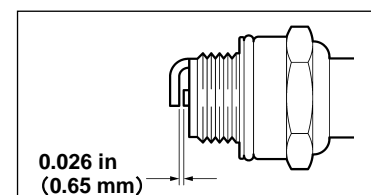

3. Carburetor Adjustment WITH limiter cap INSTALLED

1. Start and run engine for 3.5 minutes alternating RPM between, Wide Open Throttle (WOT) for 1 minute and Idle for 10 seconds.
2. Adjust idle speed throttle valve screw **(A)** to 3000 RPM +/- 200 RPM. Unit should Idle at 2800-3200 RPM. The W.O.T. (Wide Open Throttle) should be at
BCZ2650S:8500-9500 RPM BCZ2660TS:10500-11500 RPM

If engine does not run correctly after idle adjustment, follow guidelines for “4.Carburetor Adjustment WITH limiter caps REMOVED”.

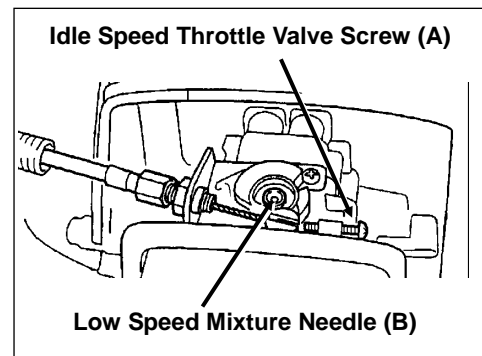

4. Carburetor Adjustment WITH limiter cap REMOVED

Low Speed Limiter Cap Removal

1. Screw limiter cap removal tool counterclockwise (CCW) 2 turns into Low **(B)** speed mixture needle limiter cap.
2. Pull limiter cap out from Low speed mixture needle hole.

NOTE: If cap is damaged and stays in the hole, use pick type tool to remove.

■ Initial Start Settings, if original needle settings were NOT disturbed

1. Turn throttle valve adjust screw **(A)** IN clockwise (CW) **ONE** and one half (1-1/2) turns.
2. Turn Low speed mixture needle **(B)** OUT counterclockwise (CCW) 1/8 turns.

■ Initial Start Settings, if original settings WERE disturbed

1. Turn throttle valve adjust screw **(A)** counterclockwise (CCW) until its tip just touches throttle plate stop. Then turn the screw in clockwise (CW) 7- 1/4 turns.
2. Turn Low speed mixture needle **(B)** counterclockwise (CCW) completely out until a clicking sound is heard. Then turn it in clockwise (CW) 14- 5/8 turns.
3. **START ENGINE USING WIDE OPEN THROTTLE** to prevent spark plug fouling.
4. If engine idles and **does not** die out at idle, continue to the warm up procedure and “**Low Speed Mixture Needle Adjustment**” on Page 3.
5. If engine **Does Not Idle and Dies Out at idle**, turn Low speed mixture needle (B) in clockwise (CW) 1/8 turn. Again **START ENGINE USING WIDE OPEN THROTTLE** and confirm idle condition.

Repeat step 6 until steady idle is obtained before moving to “**Low Speed Mixture Needle Adjustment**” procedure on Page 3.

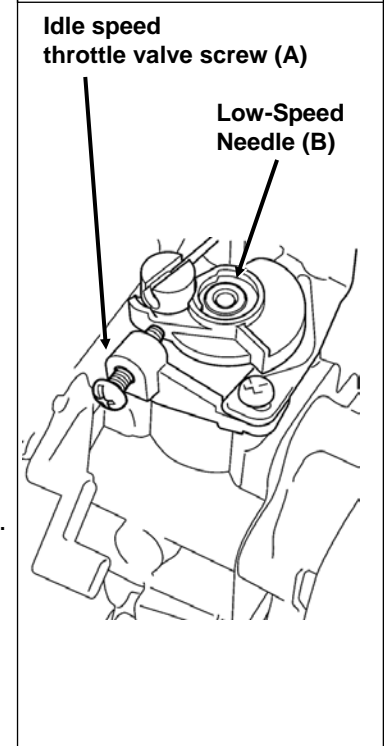
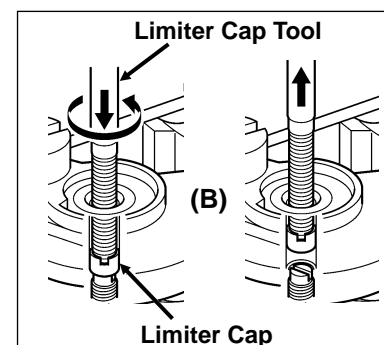

NOTE: The initial carburetor settings for throttle valve idle speed adjust screw, Low speed mixture, and High speed mixture needles are intended to start and run the engine before final carburetor adjustments are made. Actual turns required for starting engine may vary slightly.

Start and run the unit to warm up the engine. Engine must be at operating temperature before completing Low speed mixture needle adjustment. Warm up engine for minimum of 3.5 minutes by alternating between Wide Open Throttle (WOT) for 1 minute, then idle for 10 seconds.

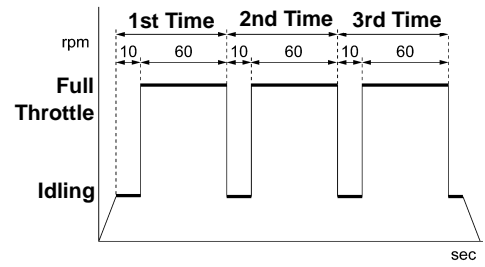

■ Low Speed Mixture Needle (B) Adjustment

- 1) Set engine Idle Speed at 3800 +/- 50 RPM by turning Idle speed throttle valve screw (A). The engine RPM should be stable in the 3800 RPM range.
- 2) **NOW** adjust Low speed mixture needle (B) Clockwise (CW) Leaning or Counter clockwise (CCW) Richening to reach Maximum engine speed AT IDLE just before lean drop off, where RPM just begins to drop.
- 3) If the idle speed at lean drop of is **HIGHER** than 3800 rpm. Adjust Idle speed throttle valve screw (A) Counterclockwise (CCW) down 500 RPM.
- 4) **Repeat** step 2) and 3) as needed using 500 RPM step reduction, until maximum lean drop of speed is reached and speed **AT IDLE** is stable at 3800 +/- 50 RPM.
- 5) Turn Low speed mixture needle (B) counterclockwise (CCW) in 1/8th turn increments and **Rich Down** the mixture 700 - 900 RPM to reduce engine speed **AT IDLE**, down to 3000 RPM.

NOTE: Engine speed must be allowed to stabilize a minimum of 20 seconds after each 1/8th of a turn adjustment of Low speed mixture needle to assure accurate tachometer readings.
Verifying Engine RPM Using Tachometer

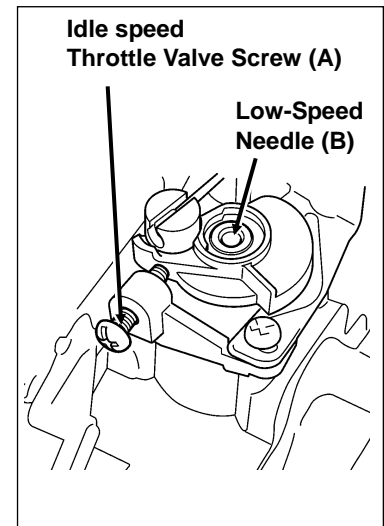

■ Checking Maximum RPM

- 1) Accelerate engine to Wide Open Throttle (WOT).
- 2) Check the acceleration state of the engine speed, and make sure that **MINIMUM** engine speed at WOT should be at:
BCZ2650S:8500 RPM BCZ2660TS:10500 RPM
- 3) After checking WOT RPM, **stop** the engine. To comply with the Emission regulations, insert new limiter cap in the Low speed mixture needle hole. Press new limiter cap deep into Low speed mixture needle hole to prevent tampering.
- 4) Re-Start engine and verify engine Idle speed range from 2800 to 3200 RPM.
- 5) Verify Wide Open Throttle (WOT) engine speed range should be at BCZ2650S:8500-9500 RPM BCZ2660TS:10500-11500 RPM and the engine should idle and accelerate smoothly.

NOTE: If problem persists, check carburetor for dirt, varnish, gum, moisture and corrosion contamination.

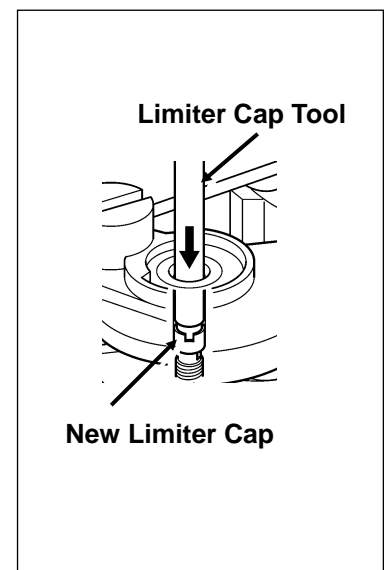

ATTENTION !!! IMPORTANT !!!

Carburetor adjustments with caps removed must be conducted by **Authorized Emission Certified Servicing Dealers ONLY**. The dealer must supply the unit to the customer in the original configuration, using manufacturer's carburetor adjustment procedure, which includes having the limiter caps in place before the unit is put into service . Knowingly removing or rendering inoperative a device, element, or design installed on or in a non-road engine which is in compliance with E.P.A. or C.A.R.B. regulations is classified as **TAMPERING**.

TAMPERING is a violation of FEDERAL LAW, resulting in significant civil penalties (fines) of up to \$25,000 for each violation.



2 Stroke Oil Requirements

Attention:

Use only RedMax "Max Life", Synthetic blend Premium Air-Cooled two-stroke engine oil or oil certified to ISO-L-**EGD** (ISO/ CD1378) standard **AND** one **that is** JASO-**FD** registered.

RedMax Air-Cooled "Max Life", Synthetic blend Premium two-stroke engine oil and ISO-L-**EGD** (ISO/ CD1378) **AND** JASO-**FD** oils are **fully compatible** with gasoline's containing 10 % Ethanol.

RedMax Air-Cooled "Max Life", Synthetic blend Premium two-stroke engine oil and ISO-L-**EGD** (ISO/ CD1378) **AND** JASO-**FD** oils are **Universal** and should be mixed at 50:1 ratio for all 2 stroke air cooled engines sold in the past regardless of mixing ratios specified in those manuals.

If the oil is registered with JASO, the JASO Logo with **FD** and **registration number** will be displayed on the container. The highest quality JASO rating is "**FD**", which equals the ISO-L-**EGD** rating. Lower ratings are "FC", "FB", and "FA".



Attention: Engine problems due to inadequate lubrication caused by failure to use ISO-L-**EGD** certified and JASO **FD** registered oil such as "Max Life", RedMax Synthetic blend Premium 2-stroke oil **WILL VOID THE RedMax TWO-STROKE ENGINE WARRANTY.**

WARNING: Do not use NMMA (National Marine Manufacturers Association), BIA (Boating Industry Association), and TCW (two cycle water cooled) oils designed for MoPeds or Outboard, water cooled Marine Engines. Do not use API (American Petroleum Institute), TC (Two Cycle) labeled oils. The API-TC test standard has been discontinued by API in 1995 and it no longer exists.

IMPORTANT: Gasoline/Oil mixture Storage Recommendations

Store your gasoline or gasoline/oil mixture in a cool dry area in a tightly sealed approved container to limit the entry of moisture and additional air (oxygen). Moisture and air cause the development of varnish and gum, making the fuel stale. Stored gasoline and gasoline/ oil mixture ages and loses its octane rating and volatility. Do not mix more gasoline/ oil than you intend to use in 30 days, and 60 days when fuel stabilizer is added. RedMax Air-Cooled "Max Life" Synthetic blend Premium two-stroke engine oil "**Contains fuel stabilizer**" and will automatically extend your gasoline/ oil mixture life up to 60 days.

9335 HARRIS CORNERS PARKWAY CHARLOTTE, NC 28269