



**OWNER'S/OPERATOR'S  
MANUAL**

**MODE D'EMPLOI**

**MANUAL DE  
INSTRUCCIONES**

**POLE SAW**

**SCIE POLAIRE**

**SIERRA DE MANGO**

**PSZ2460S**

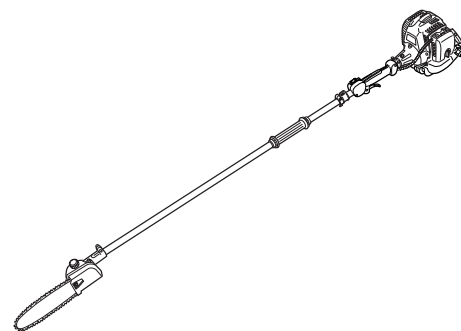

**! WARNING !**

The engine exhaust from this product contains chemicals known to the State of California to cause cancer, birth defects or other reproductive harm.

**! AVERTISSEMENT !**

Les échappements du moteur de ce produit contiennent des produits chimiques connus par l'Etat de Californie comme étant responsables de cancers, d'anomalies congénitales et d'autres atteintes à l'appareil reproducteur.

**! ADVERTENCIA !**

Los gases de escape del motor de este producto contienen sustancias químicas conocidas por el Estado de California como causantes de cáncer, malformaciones en recién nacidos y otros problemas de reproducción.

**! WARNING !**

Before using our products, please read this manual carefully to understand the proper use of your unit.

**! AVERTISSEMENT !**

Avant d'utiliser ce produit, veuillez lire attentivement ce manuel afin de bien comprendre le bon fonctionnement de cet appareil.

**! ADVERTENCIA !**

Antes de usar nuestros productos, lea detenidamente este manual a fin de familiarizarse con el uso correcto de este aparato.

This spark ignition system complies with the Canadian standard ICES-002.

Ce système d'allumage par étincelle de véhicule est conforme à la norme NMB-002 du Canada.

Este sistema de ignición por chispa de vehículo es conforme con la norma ICES-002 del Canadá.

U  
S

F  
R

E  
S



U  
S

# OWNER'S/OPERATOR'S MANUAL

## POLE SAW

**PSZ2460S**

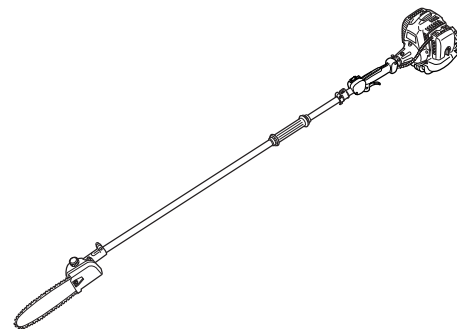

### **! WARNING !**

The engine exhaust from this product contains chemicals known to the State of California to cause cancer, birth defects or other reproductive harm.

### **! WARNING !**

Before using our products, please read this manual carefully to understand the proper use of your unit.

This spark ignition system complies with the Canadian standard ICES-002.

## SAFETY FIRST

Instructions contained in warnings within this manual marked with a  symbol concern critical points which must be taken into consideration to prevent possible serious bodily injury, and for this reason you are requested to read all such instructions carefully and follow them without fail.



### ■ WARNINGS IN THE MANUAL

#### WARNING

This mark indicates instructions which must be followed in order to prevent accidents which could lead to serious bodily injury or death.

#### IMPORTANT

This mark indicates instructions which must be followed, or it leads to mechanical failure, breakdown, or damage.

#### NOTE

This mark indicates hints or directions useful in the use of the product.

## **Contents**

---

1. Parts location.....	3
2. Specifications .....	3
3. Warning labels on the machine .....	4
4. Symbols on the machine .....	4
5. For safe operation .....	5
6. Set up .....	9
7. Fuel and Chain Oil.....	10
8. Operation.....	12
9. Maintenance .....	14
10. Storage .....	17
11. Disposal.....	17
12. Troubleshooting guide .....	17

## 1. Parts location

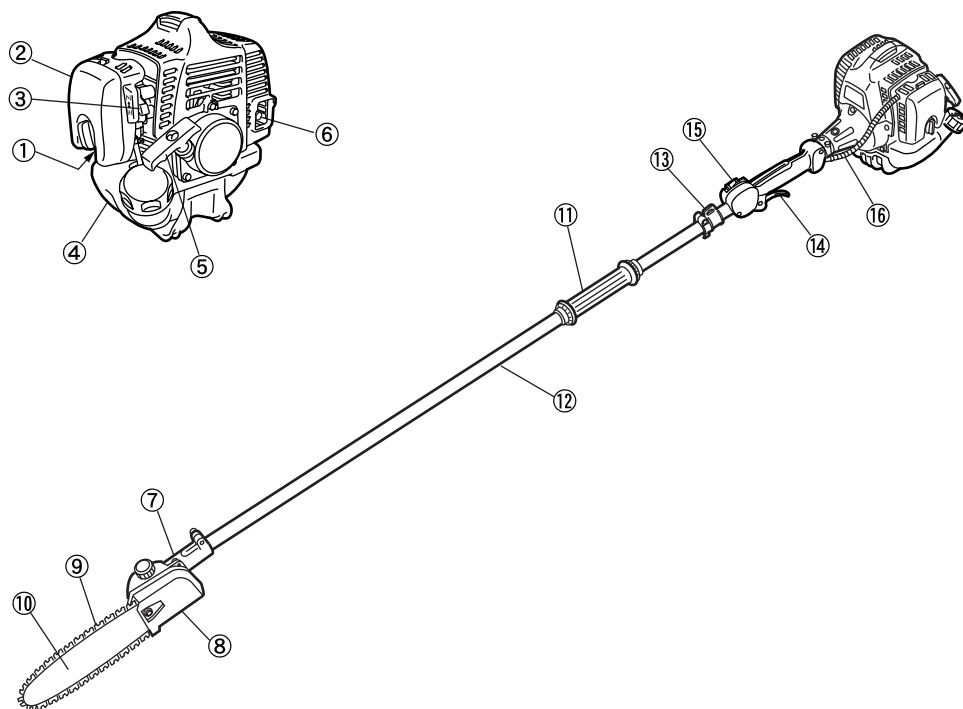

- (1) Primer pump
- (2) Air cleaner cover
- (3) Choke lever
- (4) Fuel tank
- (5) Starter knob
- (6) Spark arrester
- (7) Gear case
- (8) Chain cover
- (9) Saw chain
- (10) Guide bar
- (11) Grip
- (12) Drive shaft housing
- (13) Shoulder strap hanger
- (14) Throttle trigger
- (15) Stop switch
- (16) Throttle cable

## 2. Specifications

### ■ PSZ2460S

Overall size (LxWxH)	83.9(2130) x 9.8(250) x 12.2(310) mm
Dry weight	11.2(5.04) lbs (kg)
Engine	Type ..... Air-cooled 2-stroke gasoline
	Model ..... GZ23N
	Displacement ..... 1.5cu-in (23.6 cm <sup>3</sup> )
	Max. output ..... 1.15 Hp (0.858 kW) at 8000min <sup>-1</sup> (rpm)
	Idle speed ..... 3000±200min <sup>-1</sup> (rpm)
	Fuel ..... Mixture (Gasoline 50 : Oil 1) (when using RedMax genuine oil)
	Carburetor ..... Walbro Diaphragm type
	Spark plug ..... NGK CMR7H
	Durability period ..... 300 hrs
Fuel tank capacity	21.3 fl.oz (0.63 ℓ)
Transmission	Centrifugal clutch, Rigid driveshaft
Gear ratio	1.06
Cutting head	
Guide bar	Type ..... OREGON DOUBLE GUARD PS0011
	Size ..... 12(300) in.(mm)
Saw chain	Type ..... OREGON 90SG44X
	Pitch x Gauge ..... 3/8x0.043 (9.53 x 1.09) in.(mm)
Sprocket	7T
Oil pump	Plunger type
Standard Accessories	
Shoulder Strap	1 pc.
Goggle	1 pc.
Tool Kit	1 pc.

Specifications are subject to change without notice.

### 3. Warning labels on the machine

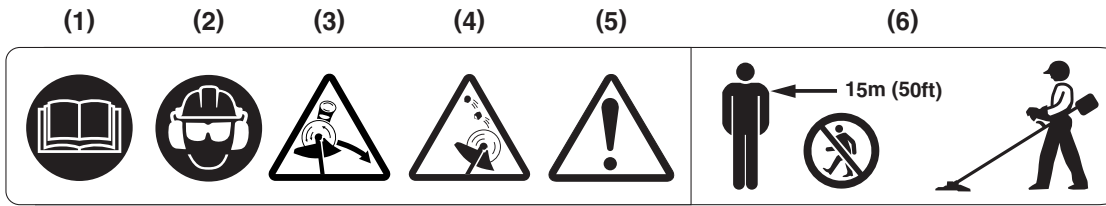

- (1) Read owner's manual before operating this machine.
- (2) Wear head, eye and ear protection.
- (3) Warning! Danger of kickback.
- (4) Beware of thrown objects.
- (5) Warning/Attention
- (6) Keep all children, bystanders and helpers 15 meters away from the brushcutter.

#### ! IMPORTANT



If warning label peel off or become soiled and impossible to read, you should contact the dealer from which you purchased the product to order new labels and affix them in the required location(s).

#### ! WARNING

Never modify your brushcutter.

We won't warrant the machine, if you use the remodeled brushcutter or you don't observe the proper usage written in the manual.

### 4. Symbols on the machine

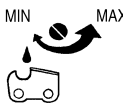
- For safe operation and maintenance, symbols are carved in relief on the machine. According to these indications, please be careful not to take a mistake.
- (a)  (a) The port to refuel the "MIX GASOLINE"  
**Position:** FUEL TANK CAP
  - (b)  (b) The direction to close the choke  
**Position:** AIR CLEANER COVER
  - (c)  (c) The direction to open the choke  
**Position:** AIR CLEANER COVER
  - (d)  (d) If you turn the rod by screwdriver follow the arrow to the "MAX" position, the chain oil flow more, and if you turn to the "MIN" position, less.  
**Position:** Bottom of the power unit

#### ■ EMISSION CONTROL

An emission control label is located on the engine.



- \*1: The year will be changed every year of manufacturing.
- \*2: The initial will be changed every year of manufacturing.
- \*3: SP : Sealed tank made of HDPE or PE.

## ▲ 5. For safe operation



1. Read this manual carefully until you completely understand and follow all safety and operating instructions.
2. Keep this manual handy so that you may refer to it later whenever any questions arise. Also note, if you have any questions which cannot be answered herein, contact the dealer from whom you purchased the product.
3. Always be sure to include this manual when selling, lending, or otherwise transferring the ownership of this product.
4. Never allow children or anyone unable to fully understand the directions given in the manual to use the machine.



### ■ WORKING CONDITION

1. When using the product, you should wear proper clothing and protective equipment.

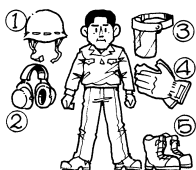

- (1) Helmet
- (2) Ear protectors
- (3) Protection goggles or face protector
- (4) Thick work gloves
- (5) Non-slip-sole work boots

2. And you should carry with you.
  - (1) Attached tools and files
  - (2) Properly reserved fuel
  - (3) Spare blade
  - (4) Things to notify your working area (rope, warning signs)
  - (5) Whistle (for collaboration or emergency)
  - (6) Hatchet or saw (for removal of obstacles)



3. Do not wear loose clothing, jewelry, short trousers, sandals, or go barefoot. Do not wear anything which might be caught by a moving part of the unit. Secure hair so it is above shoulder length.



### ■ WORKING CIRCUMSTANCE

1. Never start the engine inside a closed room or building. Exhaust gases contain dangerous carbon monoxide.
2. Never use the product:
  - a. when the ground is slippery or when you can't maintain a steady posture.
  - b. At night, at times of heavy fog, or at any other times when your field of vision might be limited and it would be difficult to gain a clear view of the working area.
  - c. During rain storms, during lightning storms, at times of strong or gale-force winds, or at any other times when weather conditions might make it unsafe to use the product.



### ■ WORKING PLAN

1. You should never use the product when under the influence of alcohol, when suffering from exhaustion or lack of sleep, when suffering from drowsiness as a result of having taken cold medicine or at any other time when a possibility exists that your judgment might be impaired or that you might not be able to operate the product properly and in a safe manner.
2. When planning your work schedule, allow plenty of time to rest. Limit the amount of time over which the product is to be used continuously to somewhere around 30–40 minutes per session, and take 10–20 minutes of rest between work sessions. Also try to keep the total amount of work performed in a single day under 2 hours or less.



### ▲ WARNING

1. If you don't observe the working time, or working manner (See ■ USING THE PRODUCT), Repetitive Stress Injury (RSI) could occur. If you feel discomfort, redness and swelling of your fingers or any other part of your body, see a doctor before getting worse.
2. To avoid noise complaints, in general, operate product between 8a.m. and 5p.m. on weekdays and 9a.m. to 5p.m. weekends.



### 📖 NOTE

Check and follow the local regulations as to sound level and hours of operations for the product.

### ■ BEFORE STARTING THE ENGINE

1. Operate the chain saw only in well ventilated areas. Never start or run the engine inside a closed room or building. Exhaust fumes contain dangerous carbon monoxide.
2. The area within a perimeter of 50 feet (15 m) of the person using the product should be considered a hazardous area into which no one should enter. If necessary yellow warning rope, warning signs should be placed around the perimeter of the area. When work is to be performed simultaneously by two or more persons, care should also be taken to constantly look around or otherwise check for the presence and locations of other people working so as to maintain a distance



## ▲ 5. For safe operation

between each person sufficient to ensure safety.

3. Check the condition of working area to avoid any accident by hitting hidden obstacles such as stumps, stones, cans, or broken grass.

### ! IMPORTANT

Remove any obstacle before beginning work.

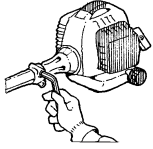

4. Inspect the entire unit for loose fasteners and fuel leakage. Make sure that the cutting attachment is properly installed and securely fastened.
5. Always use the shoulder strap. Adjust the strap for comfort before starting the engine. The strap should be adjusted so the left hand can comfortably hold the handlebar grip approximately waist high.

### ■ STARTING THE ENGINE

1. Keep bystanders and animals at least 50 feet (15 m) away from the operating point. If you are approached, immediately stop the engine.
2. The product is equipped with a centrifugal clutch mechanism, so the cutting attachment begins to rotate as soon as the engine is started by putting the throttle into the start position. When starting the engine, place the product onto the ground in a flat clear area and hold it firmly in place so as to ensure that neither the cutting part nor the throttle come into contact with any obstacle when the engine starts.

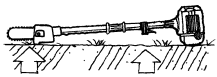

### ▲ WARNING

**Never place the throttle into the high speed position when starting the engine.**

3. After starting the engine, check to make sure that the cutting attachment stops rotating when the throttle is moved fully back to its original position. If it continues to rotate even after the throttle has been moved fully back, turn off the engine and take the unit to your authorized RedMax servicing dealer for repair.

### ■ USING THE PRODUCT

### ! IMPORTANT

**Cut only materials recommended by the manufacturer. And use only for tasks explained in the manual.**



1. Grip the handles firmly with both hands using your whole hand. Place your feet slightly apart (slightly further apart than the width of your shoulders) so that your weight is distributed evenly across both legs, and always be sure to maintain a steady, even posture while working.
2. Maintain the speed of the engine at the level required to perform cutting work, and never raise the speed of the engine above the level necessary.
3. Never operate the pruner at an angle greater than 60° in order to reduce the risk of being struck by falling objects during operation.
4. If the unit start to shake or vibrate, turn off the engine and check the whole unit. Do not use it until the trouble has been properly corrected.
5. Keep all parts of your body away from rotating cutting attachment and hot surfaces.
6. Never touch the muffler, spark plug, or other metallic parts of the engine while the engine is in operation or immediately after shutting down the engine. Doing so could result in serious burns or electrical shock.

### • IF SOMEONE COMES

1. Guard against hazardous situations at all times. Warn adults to keep pets and children away from the area. Be careful if you are approached. Injury may result from flying debris.
2. If someone calls out or otherwise interrupts you while working, always be sure to turn off the engine before turning around.

### ■ MAINTENANCE

1. In order to maintain your product in proper working order, perform the maintenance and checking operations described in the manual at regular intervals.
2. Always be sure to turn off the engine before performing any maintenance or checking procedures.

### (1) Check ok !

### ▲ WARNING

**The metallic parts reach high temperatures immediately after stopping the engine.**

3. When replacing the cutting attachment or any other part, or when replacing the oil or any lubricant, always be sure to **use only RedMax products or products which**



## ▲ 5. For safe operation

have been certified by RedMax for use with the RedMax product.

- In the event that any part must be replaced or any maintenance or repair work not described in this manual must be performed, please contact a representative from the store nearest RedMax authorized servicing dealer for assistance.
- Do not use any accessory or attachment other than those bearing the RedMax mark and recommended for the unit.
- Under no circumstances should you ever take apart the product or alter it in any way. Doing so might result in the product becoming damaged during operation or the product becoming unable to operate properly.

### ■ HANDLING FUEL

- The engine of the RedMax product is designed to run on a mixed fuel which contains highly flammable gasoline. Never store cans of fuel or refill the tank of the unit in any place where there is a boiler, stove, wood fire, electrical sparks, welding sparks, or any other source of heat or fire which might ignite the fuel.
- Never smoke while operating the unit or refilling its fuel tank.
- When refilling the tank, always turn off the engine and allow it to cool down. Take a careful look around to make sure that there are no sparks or open flames anywhere nearby before refueling.

#### (1) Refill after cooling the engine.

- Wipe spilled fuel completely using a dry rag if any fuel spillage occurs during refueling.
- After refueling, screw the fuel cap back tightly onto the fuel tank and then carry the unit to a spot 10 feet or more away from where it was refueled before turning on the engine.

### ■ TRANSPORTATION

- Never transport the pruner nor set it down with the engine running. An engine that's running could be accidentally accelerated causing the chain to rotate.
- Make sure the scabbard is in place when transporting the pruner.
- When carrying by hand, the chain should be pointing backward.
- Never transport the product over rough roads over long distances by vehicle without removing all fuel from the fuel tank. If doing so, fuel might leak from the tank

during transport.

### ■ KICKBACK AND PINCHING SAFETY PRECAUTIONS

#### Beware of kickback!

Kickback can occur whenever the tip of the guide bar touches an object while the saw is operating. Kickback may force the bar up and back toward the operator with lightning-like speed!

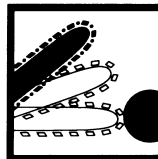

#### Beware of pinching.

Pinching the saw along the tip of the guide bar may force the bar back rapidly toward the operator. Pinching can occur whenever wood closes in around the moving chain.

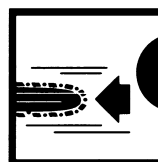

### ▲ WARNING

**Both kickback and pinching may cause you to lose control of the pole pruner which could result in serious personal injury. Do not rely exclusively on the safety device built into the pruner! You must take several steps to keep your jobs free from accident or injury:**

- Understand kickback and pinching! You can reduce or eliminate the element of surprise. Sudden surprises contributes to accidents.
- Keep a firm grip on the pole pruner with both hands whenever the engine is running. A firm grip will help you reduce the affects of kickback and pinching as well as maintain control of the machine.
- Make sure the area in which you are cutting is free from obstructions. Do not let the nose of the guide bar contact a log, branch, or any other obstructions which could be hit while you operation the pole pruner.
- Cut at high engine speeds.
- Follow the manufacturer's instructions for sharpening and maintaining the chain.
- Use only the replacement bar and chain or equivalent as specified by the manufacturer.

### ▲ WARNING

- **Make sure the chain and sprocket are correctly adjusted before operating the pruner (see page 9 for adjustment procedures). Never attempt chain adjustment with the engine running!**
- **Always make sure the cutting attachment is properly installed and firmly tightened before operation.**

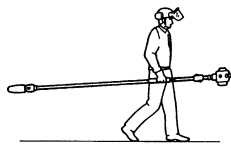
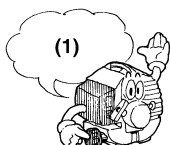



## **▲ 5. For safe operation**

---

- **Never use a cracked or warped guide bar: replace it with a serviceable one and make sure it fits properly.**
- **If a saw blade should bind fast in a cut, shut off the engine immediately. Push the branch or tree to ease the bind and free the blade.**
- **Do not operate the pole pruner with the muffler removed.**
- **When cutting a limb that is under tension, be alert for springback so that you will not be struck by the moving limb.**
- **Always stop the engine immediately and check for damage if you strike a foreign object or if the machine becomes tangled. Do not operate with broken or damaged equipment.**

### **! IMPORTANT**

- Do not make unauthorized modifications or substitutions to the guide bar or chain.
- Never allow the engine to run at high RPM without a load. Doing so could damage the engine.
- Keep the pruner as clean as possible. Keep it free of loose vegetation, mud, etc.

## 6. Set up

### ■ MOUNTING ENGINE (SE1)

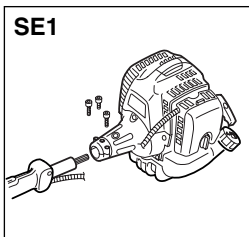

1. Push the driveshaft housing toward the clutch housing and rotate it by hand to check that the driveshaft is engaged with the gears.
2. Insert the driveshaft housing into the clutch housing until it bottoms, and align the positioning holes on the both housings and install the screw.
3. Fasten the clamp securely with 2 screws.

### ▲ WARNING

The saw chain has very sharp edges. Use protective gloves for safety.

### ■ CONNECTING THROTTLE WIRE

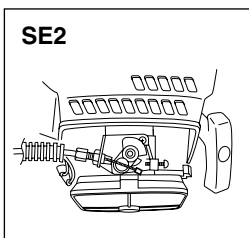

1. Remove the air cleaner cover.
2. Connect the end of the throttle wire to the joint on the top of the carburetor. (SE2)

### ■ CONNECTING SWITCH WIRES

- Connect the switch wires between the engine and the main unit. Pair the wires of the same color.

### ■ ATTACHING THE PRUNING MECHANISM (SE3)

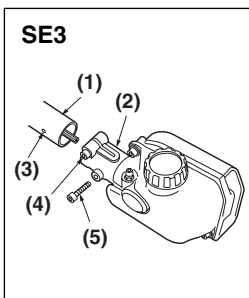

1. Remove the cap on the end of the main pipe.
2. Remove the screw screwed into the end of the gear case.
3. Insert the end of the gear case into the main pipe.
4. Line up the hole on the end of the gear case into which the screw is to be inserted with the hole on the main pipe, and screw the screw firmly in.
5. Using a wrench, screw in the bolt provided to fix the mechanism into place.

- (1) Main pipe  
(2) Gear case  
(3) Screw hole  
(4) Fastening bolt  
(5) Bolt

A standard package contains the items as shown below. (SE4)

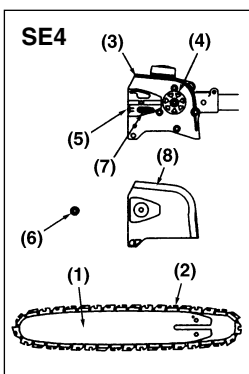

- (1) Guide bar  
(2) Saw chain  
(3) Gear case  
(4) Sprocket  
(5) Chain tension adjust screw  
(6) Nut  
(7) Chain tensioner nut  
(8) Chain cover

Install the guide bar and the saw chain on the gear case as follows.

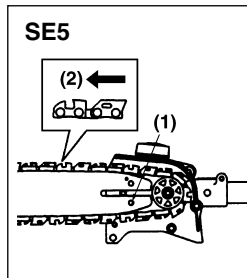

1. Loosen a nut and remove the chain cover.
2. Mount the guide bar then fit the saw chain around the bar and sprocket.(SE5)

### ▲ WARNING

Pay attention to the correct direction of the saw chain

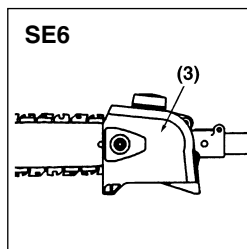

3. Fit the chain tensioner nut into the lower hole of the guide bar, then install the chain cover, and fasten the mounting nut to finger tightness. (SE5)(SE6)

- (1) Hole  
(2) Moving direction  
(3) Chain tensioner nut

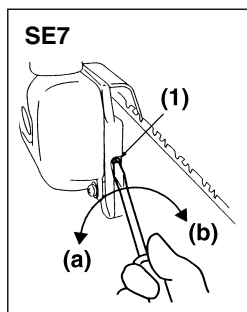

4. Adjust the chain tension by turning the tensioner screw until the tie straps just touch the bottom side of the bar rail. (SE7)

- (1) Chain tension adjusting screw  
(a) Loosen  
(b) Tighten

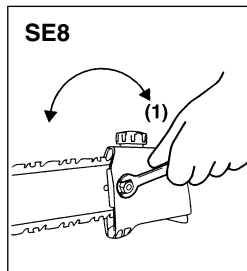

5. Tighten the mounting nut securely with the bar tip held up (SE8)(TORQUE: 8.9~11.7 N.m./90~120 kg-cm). Then check the chain for smooth rotation and correct tension while moving it by hand. If necessary, readjustment.

- (1) Tighten

### ▲ WARNING

It is very important to maintain the proper chain tension. Rapid wear of the guide bar or the chain coming off easily can be caused by improper tension. Especially when using a new chain, take good care of it since it should expand when first used.

### ■ BALANCE UNIT

1. Put on strap and attach unit to strap.
2. Depending on the working posture, slide clamp up or down until unit balances and the strap fits your body.

## 7. Fuel and Chain Oil

### ■ FUEL

#### ▲ WARNING

- Gasoline is very flammable. Avoid smoking or bringing any flame or sparks near fuel. Make sure to stop the engine and allow it cool before refueling the unit. Select outdoor bare ground for fueling and move at least 10 ft (3 m) away from the fueling point before starting the engine.



### ■ GASOLINE REQUIREMENTS

- All 2-Stroke RedMax Products are powered by RedMax Professional-Commercial Duty, Hi-Performance, Hi-RPM, Air Cooled 2-Stroke engines. RedMax – Hi-Performance 2-stroke engines produce higher HP outputs as compared to standard Home Owner Duty or Light Commercial Duty production engines offered by most manufacturers.
- Exhaust emission are controlled by the fundamental engine parameters and components (eq., carburation, ignition timing and port timing) without addition of any major hardware or the introduction of an inert material during combustion.
- The RedMax Engines are registered and certified with CARB (California Air Resources Board) and EPA (Environmental Protection Agency) to operate on CLEAN Mid-grade 89 octane or Premium, unleaded (lead-free) gasoline and RedMax Air-Cooled "Max Life", Synthetic blend Premium two-stroke engine oil mixed at 50:1 ratio.
- Unleaded gasoline is recommended to reduce the contamination of the air for the sake of your health and the environment.
- This Hi-Performance Air Cooled 2-stroke Engine requires the use of **Minimum** 89 Octane  $\left[ \frac{R+M}{2} \right]$  (Mid grade or Premium) clean gasoline. Gasoline may contain maximum of 10% Ethanol (grain alcohol) or up to 15% MTBE (Methyl tertiary-butyl ether). Gasoline containing Methanol (Wood Alcohol) is **NOT** approved.

#### NOTE

- If octane rating of the Mid Grade gasoline in your area is lower than 89 Octane use Premium Unleaded Gasoline. The majority of all 2-stroke engine manufacturers in the USA and Canada recommend using gasoline with 89 Octane or higher.

#### ▲ WARNING

- Gasoline with an octane rating lower than 89 will greatly increase the engines operating temperature. Low octane gasoline will cause detonation (knock) resulting in piston seizures and major internal engine components damage.
- Poor quality gasolines or oils may damage sealing rings, fuel

lines or fuel tank of the engine.

#### NOTE

- Failures caused by operating engines on gasoline with octane rating lower than 89 are not covered by the RedMax Two-Stroke engine warranty.

#### ▲ WARNING

- Alternative Fuels (Not Gasoline)**  
Alternative fuels, such as E-15 (15% ethanol), E-20 (20% ethanol), E-85 (85% ethanol) are **NOT** classified as gasoline and are **NOT** approved for use in RedMax 2-stroke gasoline engines. Use of alternative fuels will cause major engine performance and durability problems such as: improper clutch engagements, overheating, vapor lock, power loss, lubrication deficiency, deterioration of fuel lines, gaskets and internal carburetor components, etc... Alternative fuels cause high moisture absorption into the fuel/oil mixture leading to oil and fuel separation.

### ■ OIL REQUIREMENTS

- Use only RedMax "Max Life", Synthetic blend Premium Air-Cooled two-stroke engine oil or oil certified to ISO-L-**EGD** (ISO/CD1378) standard AND one that is JASO-FD registered. RedMax Air-Cooled "Max Life", Synthetic blend Premium two stroke engine oil and ISO-L-**EGD** (ISO/CD1378) AND JASO-**FD** oils are fully compatible with gasoline's containing 10% Ethanol. RedMax Air-Cooled "Max Life", Synthetic blend Premium two stroke engine oil and ISO-L-**EGD** (ISO/CD1378) AND JASO-**FD** oils are **Universal** and should be mixed at 50:1 ratio for all 2 stroke air cooled engines sold in the past regardless of mixing ratios specified in those manuals.
- If the oil is registered with JASO, the JASO Logo with **FD** and registration number will be displayed on the container. The highest JASO rating is "FD", which equals the ISO-L-**EGD** rating. Lower ratings are "FC", "FB", and "FA".



- Engine problems due to inadequate lubrication caused by failure to use ISO-L-**EGD** certified and JASO **FD** registered oil such as "MaxLife", RedMax Synthetic blend Premium 2-stroke oil **WILL VOID THE REDMAX TWO-STROKE ENGINE WARRANTY.**

#### ▲ WARNING

- Do not use NMMA (National Marine Manufacturers Association), BIA (Boating Industry Association), and TCW (two cycle water cooled) oils designed for MoPeds or Outboard, water cooled Marine Engines. Do not use API (American Petroleum Institute), TC (Two Cycle) labeled oils. The API-TC

## 7. Fuel and Chain Oil

test standard has been discontinued by API in 1995 and it no longer exists.

### IMPORTANT

#### Gasoline/Oil mixture Storage Recommendations

Store your gasoline or gasoline/oil mixture in a cool dry area in a tightly sealed approved container to limit the entry of moisture and additional air (oxygen). Moisture and air cause the development of varnish and gum, making the fuel stale. Stored gasoline and gasoline/oil mixture ages and loses its octane rating and volatility. Do not mix more gasoline/oil than you intend to use in 30 days, and 60 days when fuel stabilizer is added. RedMax Air-Cooled "Max Life" Synthetic blend Premium two-stroke engine oil "**Contains fuel stabilizer**" and will automatically extend your gasoline/oil mixture life up to 60 days.

#### HOW TO MIX FUEL

##### RECOMMENDED MIXING RATIO

##### GASOLINE 50 : OIL 1

(when using RedMax Air-Cooled "Max Life")

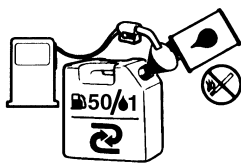

50:1 MIXING CHART

GASOLINE	gal.	1	2	3	4	5
2-CYCLE OIL	fl.oz	2.6	5.2	7.8	10.4	13

GASOLINE	liter	1	2	3	4	5
2-CYCLE OIL	ml	20	40	60	80	100

### WARNING

#### Pay attention to agitation.

1. Measure out the quantities of gasoline and oil to be mixed.
2. Put some of the gasoline into a clean, approved fuel container.
3. Pour in all of the oil and agitate well for 10seconds.
4. Pour in the rest of gasoline and agitate again for at least one minute. As some oils may be difficult to agitate depending on oil ingredients, sufficient agitation is necessary. Be careful that, if the agitation is insufficient, there is an increased danger of early piston seizure due to abnormally lean mixture.
5. Place a clear indication on the outside of the container to avoid mixing up with gasoline or other containers that dont contain oil.
6. Indicate the contents on outside of container for easy identification.

#### FUELING THE UNIT

1. Untwist and remove the fuel cap. Rest the cap on a clean surface.
2. Put fuel into the fuel tank to 80% of the full capacity.
3. Fasten the fuel cap securely and wipe up any fuel spillage around the unit.

### WARNING

1. Select flat and bare ground for fueling.
2. Move at least 10 feet (3 meters) away from the fueling point before starting the engine.
3. Stop the engine before refueling the unit. At that time, be sure to sufficiently agitate the mixed gasoline in the container.

#### FOR YOUR ENGINE LIFE, AVOID

1. FUEL WITH NO OIL (RAW GASOLINE) – It will cause severe damage to the internal engine parts very quickly.
2. GASOHOL – It can cause deterioration of rubber and/or plastic parts and disruption of engine lubrication.
3. OIL FOR 4-CYCLE ENGINE USE – It can cause spark plug fouling, exhaust port blocking, or piston ring seizure.
4. **Mixed fuels which have been left unused for a period of one month or more** may clog the carburetor and result in the engine failing to operate properly.
5. In the case of storing the product for a long period of time, clean the fuel tank after rendering it empty. Next, Start the engine and run the carburetor dry residual fuel.
6. In the case of scrapping the used mixed oil container, scrap it only at an authorized depository site.

### NOTE

- As for details of quality assurance, read the description in the section Limited Warranty carefully. Moreover, normal wear and change in product with no functional influence are not covered by the warranty. Also, be careful that, if the usage in the instruction manual is not observed as to the mixed gasoline, type of oil or fuel to be used. described therein, it may not be covered by the warranty.

#### CHAIN OIL

Use motor oil SAE #10W-30 all year round or SAE #30 ~ #40 in summer and SAE #20 in winter.

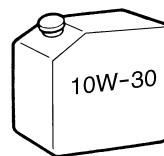

### NOTE

Do not use wasted or regenerated oil that can cause damage to the oil pump.

## 8. Operation

### ■ STARTING ENGINE

#### ⚠ WARNING

The cutting head will start rotating upon the engine starts.

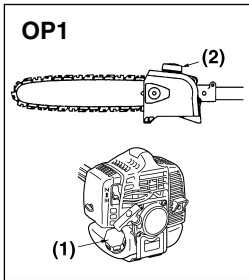

1. Feed fuel and chain oil into their respective tanks and tighten the caps securely. (OP1)

- (1) Fuel  
(2) Chain oil

2. Rest the unit on a flat, firm place. Keep the cutting head off the ground and clear of surrounding objects as it will start rotating upon starting of the engine.

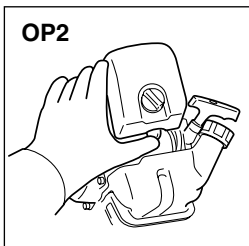

3. Push the primer pump several times until overflow fuel flows out in the clear tube. (OP2)

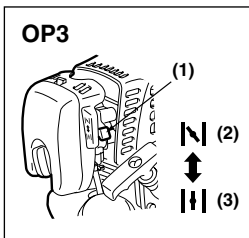

4. Move the choke lever to the closed position. (OP3)

- (1) choke lever  
(2) close  
(3) open

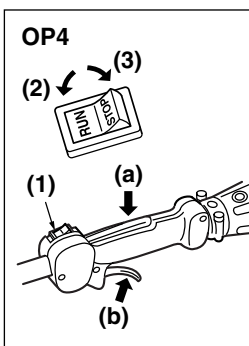

5. Set the stop switch to the "RUN" position. Place the unit on a flat, firm place. Keep the cutting head clear of everything around it. (OP4)

- (1) stop switch  
(2) RUN  
(3) STOP  
  
(a) lockout lever  
(b) throttle trigger

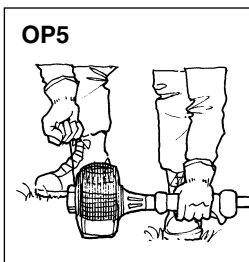

6. Firmly grasp (a) and (b) with left hand (OP4), pull the starter knob quickly until engine fires. Release throttle trigger after engine starts. (OP5)

#### ⚠ IMPORTANT

- Avoid pulling the rope to its end or returning it by releasing the knob. Such actions can cause starter failures.

7. Move the choke lever downward to open the choke. And restart the engine. (OP3)
8. Allow the engine to warm up for a several minutes before starting operation.

#### 📖 NOTE

1. When restarting the engine immediately after stopping it, leave the choke open.
2. Overchoking can make the engine hard to start due to excess fuel. When the engine failed to start after several attempts, open the choke and repeat pulling the rope, or remove the spark plug and dry it.

### ■ STOPPING ENGINE (OP4)

1. Release the throttle lever and run the engine for a half minute.
2. Shift the ignition switch to the "Stop" position. (OP4)

#### ⚠ IMPORTANT

- Except for an emergency, avoid stopping the engine while pulling the throttle lever.

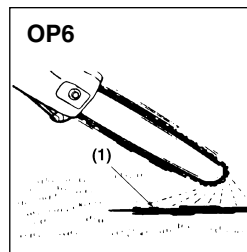

### ■ CHECKING OIL SUPPLY

- After starting the engine, run the chain at medium speed and see if chain oil is scattered off as shown in the figure. (OP6)

- (1) Chain oil

#### 📖 NOTE

The oil reservoir has a capacity sufficient to provide about 40 minutes of cutting time (when set to deliver the minimum flow rate, or about as long as you'll get from a tank of fuel). Be sure to refill the oil tank every time when refueling the saw.

## 8. Operation

### ■ ADJUSTING OIL FLOW RATE

#### ⚠ WARNING

Never fill the oil reservoir nor adjust the oiler with the engine running.

#### ❗ IMPORTANT

An increase in bar oil flow rate will speed oil consumption, requiring more frequent checks on the oil reservoir. To ensure sufficient lubrication, it may be necessary to check the oil level more frequently than at fuel tank refills.

The guide bar and chain are lubricated automatically by a pump that operates whenever the chain rotates. The pump is set at the factory to deliver a minimum flow rate, but it can be adjusted in the field. A temporary increase in oil flow is often desirable when cutting things like hardwood or wood with a lot of pitch.

#### Adjust the pump as follows:

1. Stop the engine and make sure the stop switch is in the OFF position.
2. Place the unit on its side with the oil reservoir up. (OP7)

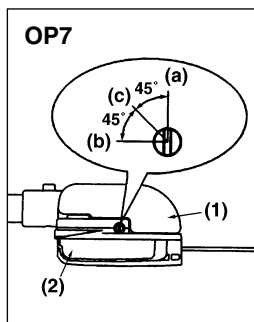

- (1) Oil tank  
(2) Chain cover

#### ❗ IMPORTANT

The oil flow adjusting screw must be pressed in slightly in order to turn. Failure to do so could damage the pump and screw.

3. With a screwdriver, push in on the oil flow rate adjusting screw and turn in the desired direction (there are three incremental settings):

- (a) Clockwise-decrease lubrication.  
(b) Counter clockwise-increase lubrication.  
(c) Middle

#### OP8

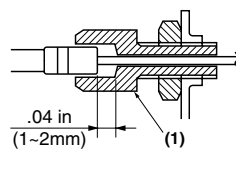

### ■ ADJUSTING THROTTLE CABLE

- The normal play is 1 or 2mm when measured at the carburetor side end. Readjust with the cable adjuster as required. (OP8)

- (1) Cable adjuster

#### OP9

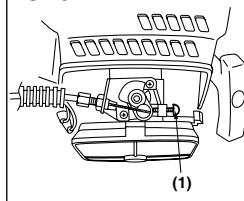

### ■ ADJUSTING IDLING SPEED (OP9)

1. When the engine tends to stop frequently at idling mode, turn the adjusting screw clockwise.
2. When the cutting head keeps rotating after releasing the trigger, turn the adjusting screw counter-clockwise.

- (1) Idle adjusting screw

#### 📖 NOTE

- Warm up the engine before adjusting the idling speed.

#### ⚠ WARNING

- Always wear work gloves made of leather or some other sturdy material when using the polesaw.
- Falling branches may fall onto the face or into the eyes, resulting in injuries, scratches, and cuts, and for this reason you should always be sure to wear a helmet and face protector when using your polesaw.



## 9. Maintenance

Maintenance, replacement, or repair of the emission control device and systems may be performed by any non-road engine repair establishment or individual.

### MAINTENANCE CHART

	System/component	Procedure	Before use	Every 25 hours after	Every 50 hours after	Every 100 hours after	note
ENGINE	fuel leaks, fuel spillage	wipe out	✓				
	fuel tank, air filter, fuel filter	inspect/clean	✓	✓			replace, if necessary
	idle adjusting screw	see ■ADJUSTING IDLING SPEED (p.13)	✓				replace carburetor if necessary
	spark plug	clean and readjust electrode gap			✓		GAP: .025in(0.6~0.7 mm) replace, if necessary
	cylinder fins, intake air cooling vent	clean		✓			
	muffler, spark arrester, cylinder exhaust port	clean, remove piled up carbon				✓	
SHAFT	throttle lever, ignition switch	check operation	✓				
	gear case	grease		✓			
	screws/nuts/bolts	tighten/replace	✓			✓	not adjusting screws
CUTTING UNIT	oiling port	clean	✓				
	guide bar	clean	✓				
	sprocket	inspect/replace			✓		
	saw chain	inspect/replace	✓				

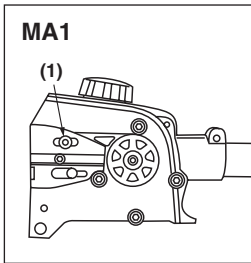

#### ■ OILING PORT

Dismount the guide bar and check the oiling port for clogging. (MA1)

(1) Oiling port

#### ■ OTHERS

Check for fuel leakage and loose fastenings or damage to major parts, especially housing joints and guide bar mounting. If any defects are found, make sure to have them repaired before operating again.

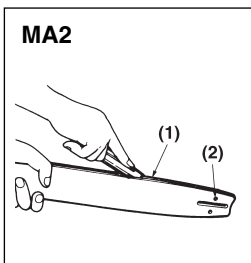

#### ■ GUIDE BAR

Remove sawdust in the bar groove and the oiling port. (MA2)

(1) Groove  
(2) Oiling port

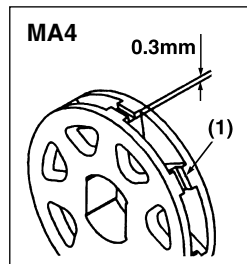

#### ■ SPROCKET

Check for extensive wear, and replace it when the teeth are worn over 0.3mm. (MA4)

(1) Sprocket

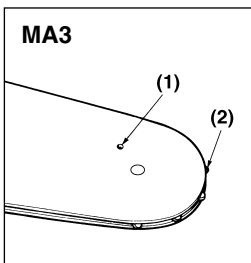

(Type: Sprocket nose)  
Grease the nose sprocket from the feeding port on the tip of the bar. (MA3)

(1) Grease port  
(2) Sprocket

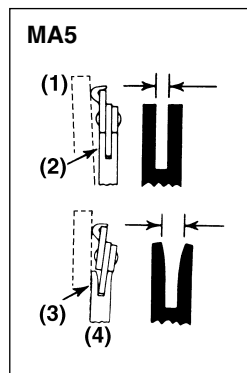

#### ■ GUIDE BAR

The bar rail should always be a square. Check for wear of the bar rail. Apply a ruler to the bar and the outside of a cutter. If a gap is observed between them, the rail is normal. Otherwise, the bar rail is worn. Such a bar needs to be corrected or replaced. (MA5)

(1) Ruler  
(2) Gap  
(3) No gap  
(4) Chain tilts

## 9. Maintenance

### ■ SAW CHAIN



**It is very important for smooth and safe operation to keep the cutters always sharp.**

Your cutters need to be sharpened when:

- Sawdust becomes powder-like.
- You need extra force to saw in.
- The cut way does not go straight.
- Vibration increases.
- Fuel consumption increases.

**Cutter setting standards:**



**Be sure to wear safety gloves.**

**Before filing:**

- Make sure the saw chain is held securely.
- Make sure the engine is stopped.
- Use a round file of proper size for your chain.

**Chain type : 90SG**

**File size : 5/32 in (4.0mm)**

Place your file on the cutter and push straight forward. Keep the file position as illustrated. (MA6)

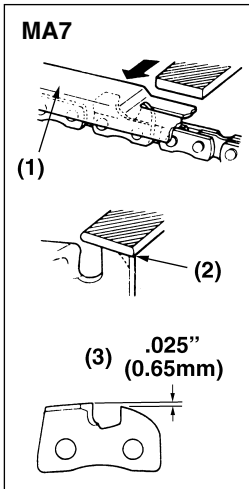
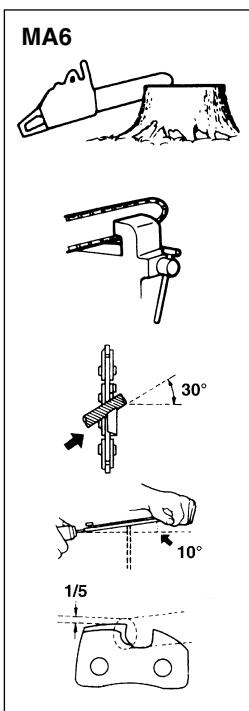

After every cutter has been set, check the depth gauge and file it to the proper level as illustrated. (MA7)



**Be sure to round off the front edge to reduce the chance of kickback or tie-strap breakage.**

- (1) Appropriate gauge checker
- (2) Make the shoulder round
- (3) Depth gauge standard

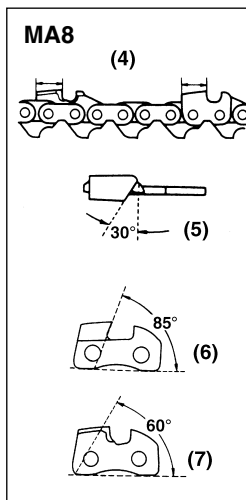

Make sure every cutter has the same length and edge angles as illustrated. (MA8)

- (4) Cutter length
- (5) Filing angle
- (6) Side plate angle
- (7) Top plate cutting angle

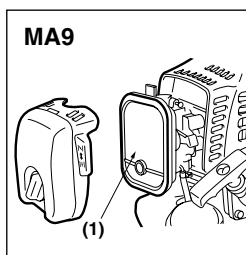

### ■ AIR FILTER

- The air filter, if clogged, will reduce the engine performance. Check and clean the filter element. If the element is broken or clogged, replace with a new one. (MA9)

(1) Air filter

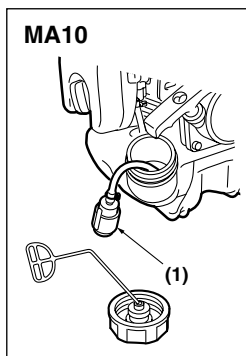

### ■ FUEL FILTER

- When the engine runs short of fuel supply, check the fuel cap and the fuel filter for blockage. (MA10)

(1) Fuel filter

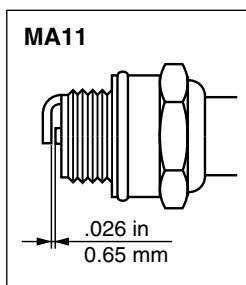

### ■ SPARK PLUG

- Starting failure and mis-firing are often caused by a fouled spark plug. Clean the spark plug and check that the plug gap is in the correct range. For a replacement plug, use the correct type specified by RedMax. (MA11)
- **REPLACEMENT PLUG IS A NGK CMR7H.**



- Note that using any spark plug other than those designated may result in the engine failing to operate properly or in the engine becoming overheated and damaged.
- To install the spark plug, first turn the plug until it is finger tight, then tighten it a quarter turn more with a socket wrench.



## 9. Maintenance

### TIGHTENING TORQUE:

**87–121 (in-lbs)**

**(9.8–13.7 N.m.)**

#### ■ MUFFLER

### **⚠ WARNING**

- Inspect periodically, the muffler for loose fasteners, any damage or corrosion. If any sign of exhaust leakage is found, stop using the machine and have it repaired immediately.
- **Note that failing to do so may result in the engine catching on fire.**

#### ■ SPARK ARRESTER (MA12)

- The muffler is equipped with a spark arrester to prevent red hot carbon from flying out of the exhaust outlet. Periodically inspect and clean as necessary with a wire brush. In the State of California it is required by law (Section 4442 of the California Public Resources Code) to equip a spark arrester when a gas powered tool is used in any forest covered, brush covered, or grass covered unimproved land.

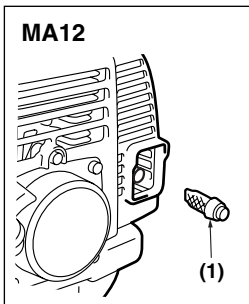

(1) Spark arrester

#### ■ GEAR CASE (MA13)

- The reduction gears are lubricated by multipurpose, lithium-based grease in the gearcase.
- Supply new grease every 25 hours of use or more often depending on the job condition.
- When adding lubricant, use a grease gun to insert lubricant into the three grease nipples located on the gear case.

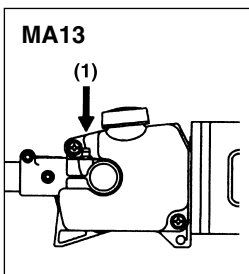

(1) Grease fitting

#### ■ INTAKE AIR COOLING VENT

### **⚠ WARNING**

- **Never touch the cylinder, muffler, or spark plugs with your bare hands immediately after stopping the engine. The engine can become very hot when in operation, and doing so could result in severe burns.**
- **When checking the machine to make sure that it is okay before using it,**

**check the area around the muffler and remove any wood chips or leaves which have attached themselves to the brushcutter. Failing to do so could cause the muffler to become overheated, and that this in turn could cause the engine to catch on fire. Always make sure that the muffler is clean and free of wood chips, leaves, and other waste before use.**

- Check the intake air cooling vent and the area around the cylinder cooling fins after every 25 hours of use for blockage, and remove any waste which has attached itself to the brushcutter. Note that it is necessary to remove the engine cover shown in (MA14) in order to be able to view the upper part of the cylinder.

### **ⓘ IMPORTANT**

- If waste gets stuck and causes blockage around the intake air cooling vent or between the cylinder fins, it may cause the engine to overheat, and that in turn may cause mechanical failure on the part of the brushcutter. (MA14)

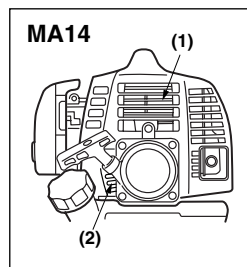

(1) cylinder

(2) intake air cooling vent (back)

#### ■ PROCEDURES TO BE PERFORMED AFTER EVERY 100 HOURS OF USE

1. Remove the muffler, insert a screwdriver into the vent, and wipe away any carbon buildup. Wipe away any carbon buildup on the muffler exhaust vent and cylinder exhaust port at the same time.
2. Tighten all screws, bolts, and fittings.
3. Check to see if any oil or grease has worked its way in between the clutch lining and drum, and if it has wipe it away using oil-free, lead-free gasoline.

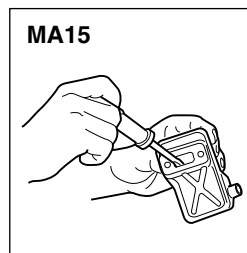

## 10. Storage

- Aged fuel is one of major causes of engine starting failure. Before storing the unit, empty the fuel tank and run the engine until it uses all the fuel left in the fuel line and the carburetor. Store the unit indoor taking necessary measures for rust prevention.

## 11. Disposal

- When disposing your machine, fuel or oil for the machine, be sure to allow your local regulations.

## 12. Troubleshooting guide

### Case 1. Starting failure

CHECK	PROBABLE CAUSES	ACTION
fuel tank	→ incorrect fuel	→ drain it and with correct fuel
fuel filter	→ fuel filter is clogged	→ clean
carburetor adjustment screw	→ out of normal range	→ adjust to normal range
spark plug (no spark)	→ spark plug is fouled/wet	→ clean/dry
	→ plug gap is incorrect	→ correct (GAP: 0.6 – 0.7 mm)
spark plug	→ disconnected	→ retighten

### Case 2. Engine starts but does not keep running/Hard re-starting.

CHECK	PROBABLE CAUSES	ACTION
fuel tank	→ incorrect fuel or staled fuel	→ drain it and with correct fuel
carburetor adjustment screw	→ out of normal range	→ adjust to normal range
muffler,cylinder (exhaust port)	→ carbon is built-up	→ wipe away
air cleaner	→ clogged with dust	→ replace
cylinder fin, fan cover	→ clogged with dust	→ clean

When your unit seems to need further service, please consult with our service shop in your area.

**FEDERAL AND CALIFORNIA EMISSIONS CONTROL WARRANTY**  
**STATEMENT YOUR WARRANTY RIGHTS AND OBLIGATIONS**

The EPA (U.S. Environmental Protection Agency), CARB (California Air Resources Board), Environment Canada and RedMax are pleased to explain the emissions control system's warranty on your 2009 and later small off-road engine. In U.S. and Canada, new equipment that use small off-road engines must be designed, built, and equipped to meet the applicable Federal or Californian stringent anti-smog standards. RedMax must warrant the emissions control system on your small off-road engine for the period listed below provided there has been no abuse, neglect or improper maintenance of your equipment. Your emissions control system may include parts such as carburetor, ignition system, catalytic converter, fuel tank, filters and other associated components. Also, included may be hoses, belts, connectors, sensors, and other emission-related assemblies. Where a warrantable condition exists, RedMax will repair your small off-road engine at no cost to you including diagnosis, parts and labor.

**MANUFACTURER'S WARRANTY COVERAGE**

This emissions control system is warranted for two years or if the product qualifies for a longer warranty period resulting from the type of use, that period shall prevail. If any emissions-related part on your equipment is defective, the part will be repaired or replaced by RedMax.

**OWNER'S WARRANTY RESPONSIBILITIES**

As the small off-road engine owner, you are responsible for performance of the required maintenance listed in your Owner's Manual. RedMax recommends that you retain all receipts covering maintenance on your small off-road engine, but RedMax cannot deny warranty solely for the lack of receipts or your failure to ensure the performance of all scheduled maintenance. As the small off-road engine owner, you should however be aware that the RedMax may deny you warranty coverage if your small off-road engine or a part has failed due to abuse, neglect, or improper maintenance or unapproved modifications.

You are responsible for presenting your small off-road engine to a RedMax distribution center or service center as soon as the problem exists. The warranty repairs should be completed in a reasonable amount of time, not to exceed 30 days. If you have any questions regarding your warranty coverage, you should contact RedMax at 1-800-291-8251 or via e-mail at [service@redmax.com](mailto:service@redmax.com).

**WARRANTY COMMENCEMENT DATE**

The warranty period begins on the date the engine or equipment is delivered to an ultimate purchaser.

**LENGTH OF COVERAGE**

RedMax warrants to the ultimate purchaser and each subsequent owner that the engine or equipment is designed, built, and equipped so as to conform with all applicable regulations adopted by EPA and CARB, and is free from defects in materials and workmanship that causes the failure of a warranted part for a period of two years.

**WHAT IS COVERED**

**REPAIR OR REPLACEMENT OF PARTS** Repair or replacement of any warranted part under the warranty must be performed at no charge to the owner at a warranty station. Warranty services or repairs will be provided at all RedMax distribution centers that are franchised to service the subject engines. Throughout the emissions warranty period of two years, RedMax must maintain a supply of warranted parts sufficient to meet the expected demand for such parts.

**WARRANTY PERIOD** Any warranted part that is scheduled for replacement as required in the maintenance schedule, is warranted for the period of time prior to the first scheduled replacement point for that part. If the part fails prior to the first scheduled replacement, the part will be repaired or replaced by RedMax at no cost. Any such part repaired or replaced under warranty is warranted for the remainder of the period prior to the first scheduled replacement point for the part. Any warranted part that is not scheduled for replacement as required in the maintenance schedule, is warranted for two years or if the product qualifies for a longer warranty period resulting from the type of use, that period shall prevail. If any such part fails during the period of warranty coverage, it will be repaired and replaced by RedMax at no cost. Any such part repaired or replaced under the

warranty is warranted for the remaining warranty period. Any warranted part that is scheduled only for regular inspection in the maintenance schedule will be warranted for a period of two years. A statement in such written instructions to the effect of "repair or replace as necessary" will not reduce the period of warranty coverage. Any such part repaired or replaced under warranty will be warranted for the remaining warranty period.

**DIAGNOSIS** The owner must not be charged for diagnostic labor that leads to the determination that a warranted part is in fact defective, provided that such diagnostic work is performed at a warranty station.

**CONSEQUENTIAL DAMAGES** RedMax is liable for damages to other engine components proximately caused by a failure under warranty of any warranted part.

#### **EMISSION WARRANTY PARTS LIST**

1. Air-induction system\*
  2. Fuel system\*
  3. Ignition system\*
  4. Fuel tank, cap and lines as applicable\*
- \*some components only covered up to point specified by maintenance schedule

#### **WHAT IS NOT COVERED**

All failures caused by abuse, neglect or improper maintenance are not covered.

#### **ADD-ON OR MODIFIED PARTS**

Add-on or modified parts that are not exempted by CARB or EPA may not be used. The use of any non-exempted add-on or modified parts will be grounds for disallowing a warranty claim. RedMax will not be liable to warrant failures of warranted parts caused by the use of a non-exempted add-on or modified part.

#### **HOW TO FILE A CLAIM**

If you have any questions regarding your warranty rights and responsibilities, you should contact your nearest authorized servicing dealer or contact RedMax at 1-800-291-8251 or via e-mail at [service@redmax.com](mailto:service@redmax.com).

#### **WHERE TO GET WARRANTY SERVICE**

Warranty services or repairs are provided through all RedMax authorized servicing dealers.

#### **MAINTENANCE, REPLACEMENT AND REPAIR OF EMISSION-RELATED PARTS**

Any replacement part may be used in the performance of any warranty maintenance or repairs and must be provided without charge to the owner. Such use will not reduce the warranty obligations of the manufacturer.

#### **MAINTENANCE STATEMENT**

The owner is responsible for the performance of all required maintenance, as defined in the operator's manual.