



# SPARE PARTS LIST

HEDGE TRIMMERS /POLE HEDGE  
TRIMMERS

CHTZ600

**A** CHTZ600  
STARTER

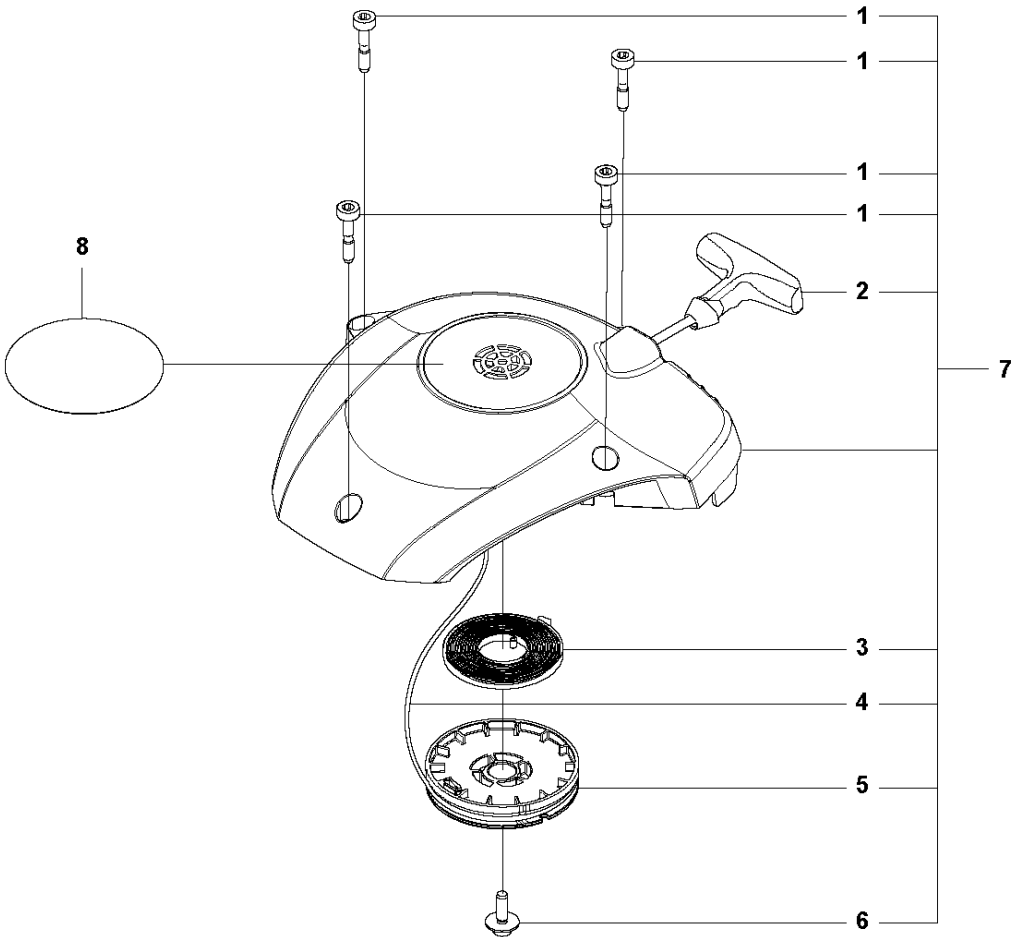

STARTER

CHTZ600

Ref	Part No	Description	Remark	QTY	KIT
1	504 08 80-01	SCREW ITXSCM		4	7
2	575 48 95-01	STARTER HANDLE		1	7
3	575 89 64-01	SPRING		1	7
4	574 28 69-02	STARTER CORD		1	7
5	590 04 90-01	STARTER PULLEY		1	7
6	577 22 61-02	SCREW ITXSCT		1	7
7	597 02 89-02	STARTER ASSY		1	
8	593 88 90-02	LABEL	CHTZ600	1	

**B** CHTZ600  
CYLINDER COVER

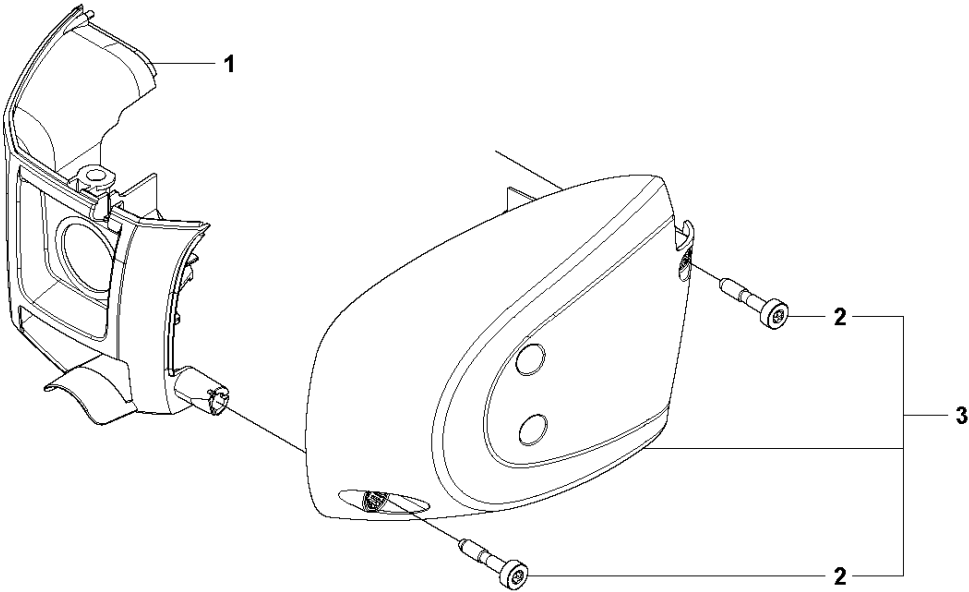

CYLINDER COVER

CHTZ600

Ref	Part No	Description	Remark	QTY	KIT
1	590 04 99-02	CYLINDER COVER		1	
2	504 08 80-01	SCREW ITXSCM		2	3
3	597 02 06-02	HEAT PROTECTOR		1	

**C** CHTZ600  
CARBURETOR & AIRFILTER

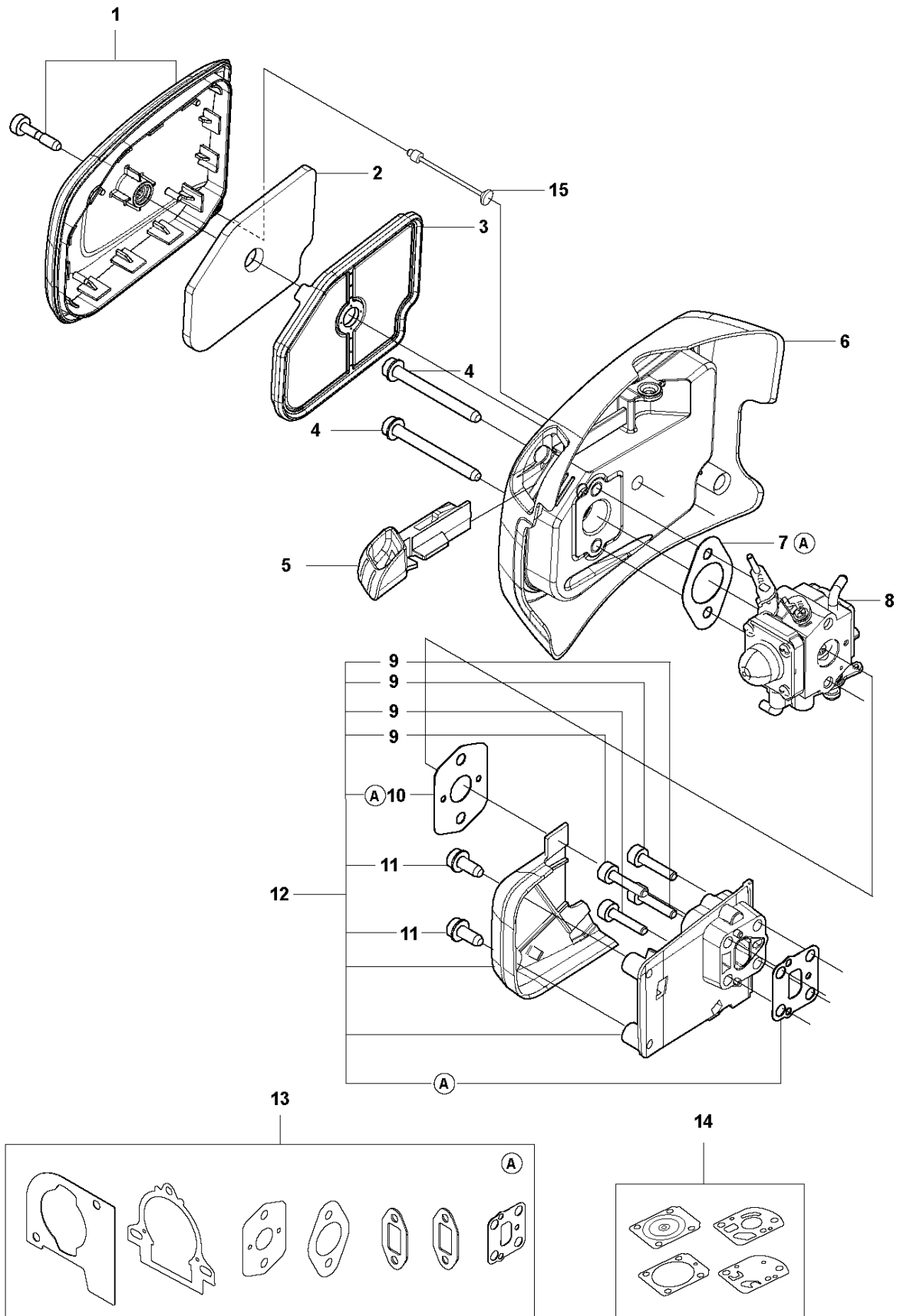

## CARBURETOR &amp; AIR FILTER

CHTZ600

Ref	Part No	Description	Remark	QTY	KIT
1	597 02 91-02	FILTER COVER		1	
2	590 04 79-01	FILTER		1	
3	590 04 07-01	FILTER		1	
4	573 92 58-02	SCREW ITXSCFT		2	
5	590 04 16-01	CHOKE		1	
6	593 17 05-01	FILTER HOLDER ASSY		1	
7	577 88 24-02	GASKET		1	13
8	596 65 83-01	CARBURETTOR		1	
9	525 76 09-04	SCREW ITXSCM		4	12
10	525 54 85-01	GASKET		1	12, 13
11	573 92 58-05	SCREW ITXSCFT		2	12
12	597 02 90-01	MANIFOLD		1	
13	597 02 10-01	GASKET KIT		1	
14	588 98 60-01	CARBURETTOR KIT	CARBURETTOR	1	
15	590 74 01-01	SNAP LOCKING		1	

**D** CHTZ600  
FUEL TANK

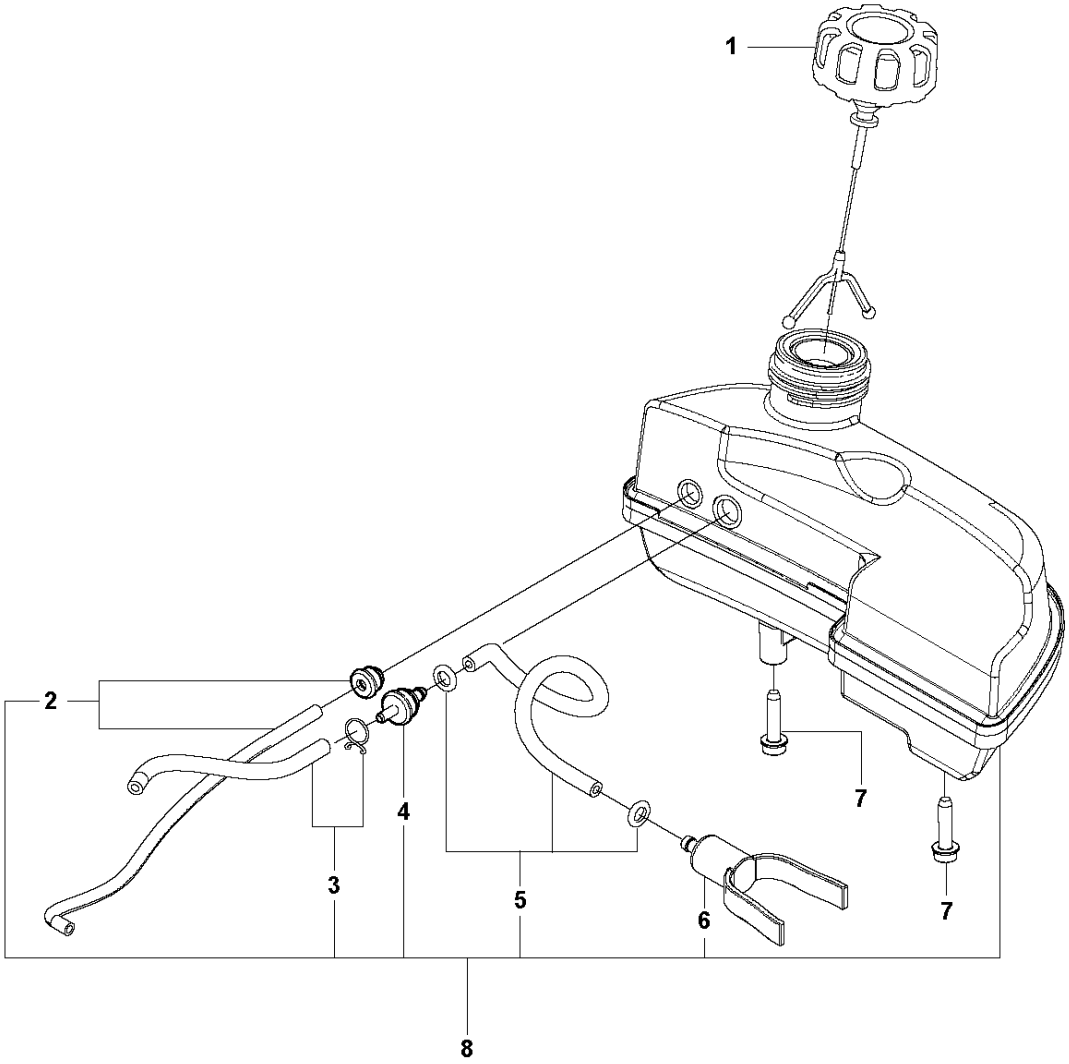



FUEL TANK

CHTZ600

Ref	Part No	Description	Remark	QTY	KIT
1	504 11 32-03	TANK CAP		1	
2	597 02 12-01	HOSE KIT		1	8
3	597 02 13-01	HOSE KIT		1	8
3	597 02 13-02	HOSE KIT	For US/CAN market	1	8
4	578 29 56-01	HOSE NIPPLE		1	8
5	597 02 14-01	HOSE KIT		1	8
6	574 60 39-01	FUEL FILTER		1	8
7	521 51 81-01	SCREW		2	
8	597 02 15-01	FUEL TANK KIT		1	
8	597 02 15-02	FUEL TANK KIT	For US/CAN market	1	

**E** CHTZ600  
IGNITION SYSTEM

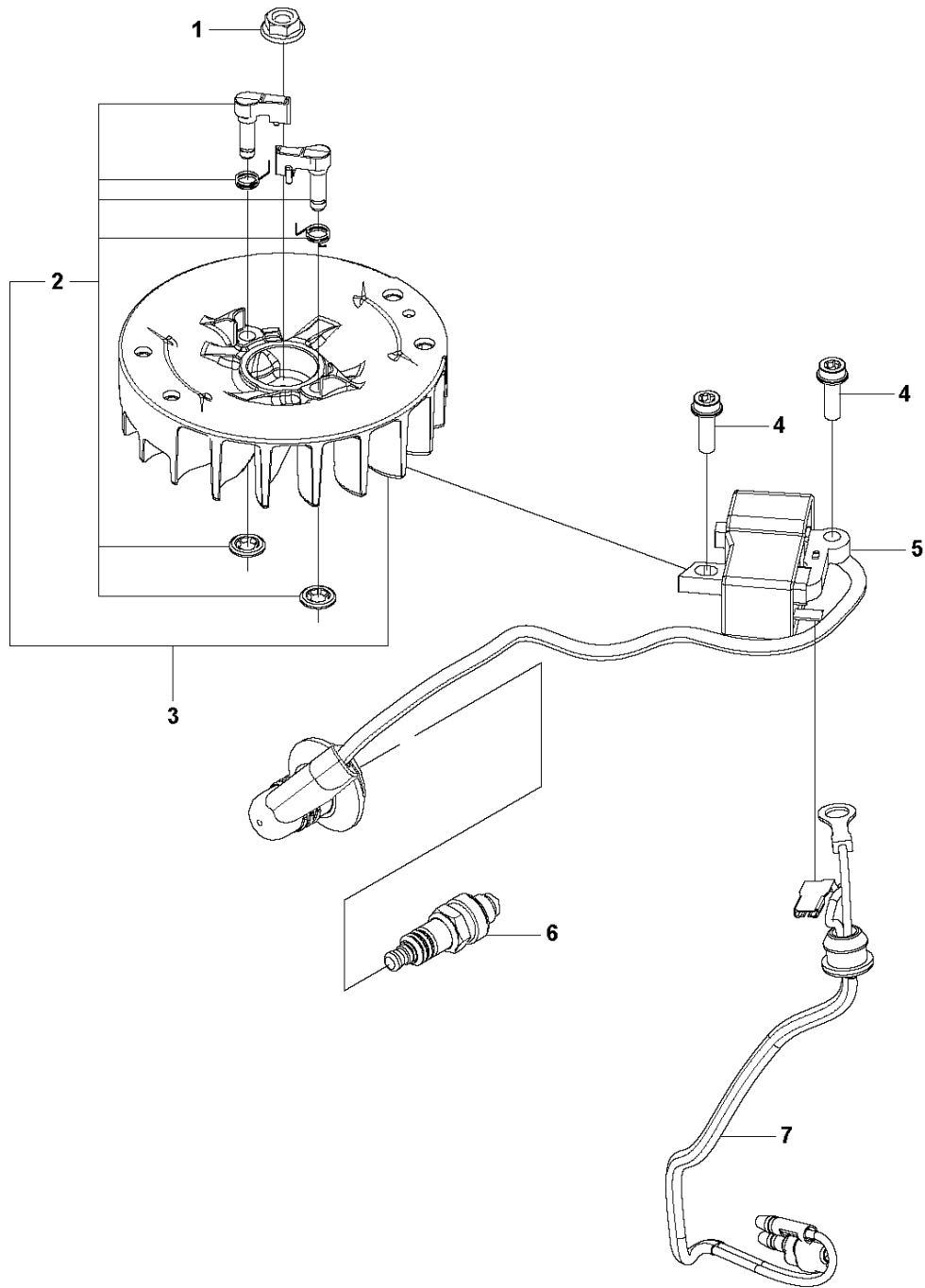

## IGNITION SYSTEM

CHTZ600

Ref	Part No	Description	Remark	QTY	KIT
1	731 71 16-51	HEXAGON NUT FLANGE		1	
2	597 02 93-01	SCREW KIT		1	3
3	525 73 95-01	FLYWHEEL ASSY		1	
4	525 75 51-01	SCREW ITXSCFM		2	
5	585 07 40-02	IGNITION MODULE		1	
6	503 23 54-01	SPARK PLUG		1	
7	574 48 89-04	SHORT CIRCUIT CABLE		1	

**F** CHTZ600  
MUFFLER

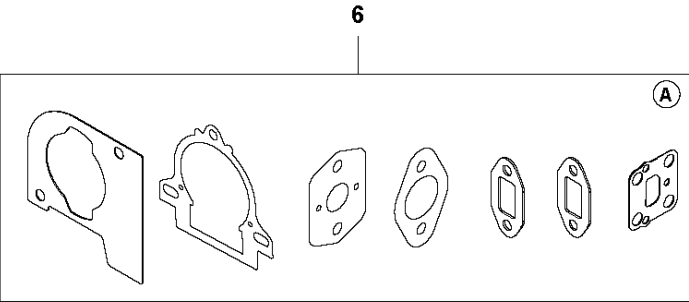
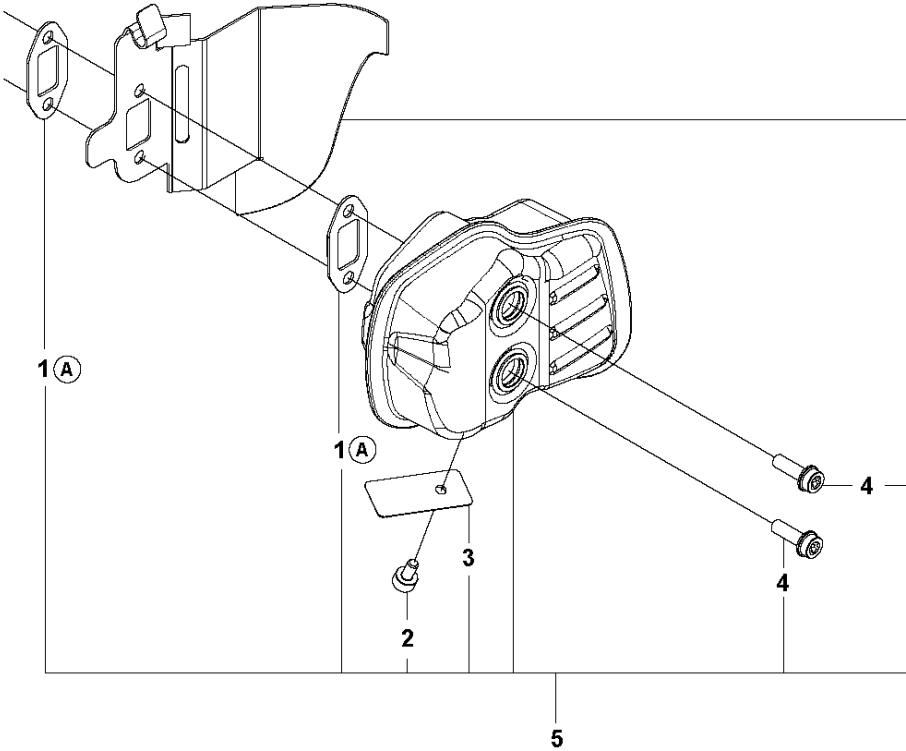

MUFFLER

CHTZ600

Ref	Part No	Description	Remark	QTY	KIT
1	522 99 73-01	GASKET		2	5, 6
2	504 08 79-01	SCREW ITXSCM		1	5
3	525 74 16-01	SPARK ARRESTER		1	5
4	525 75 51-01	SCREW ITXSCFM		2	5
5	593 87 64-01	MUFFLER ASSY		1	
6	597 02 10-01	GASKET KIT		1	

**G** CHTZ600  
CYLINDER & PISTON

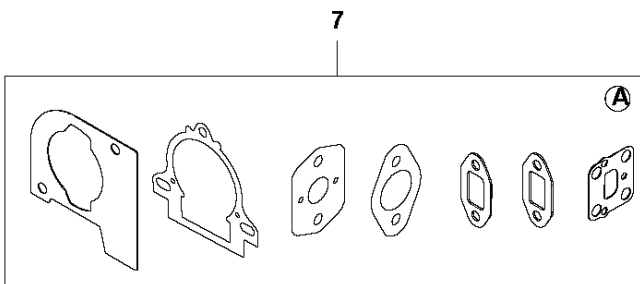
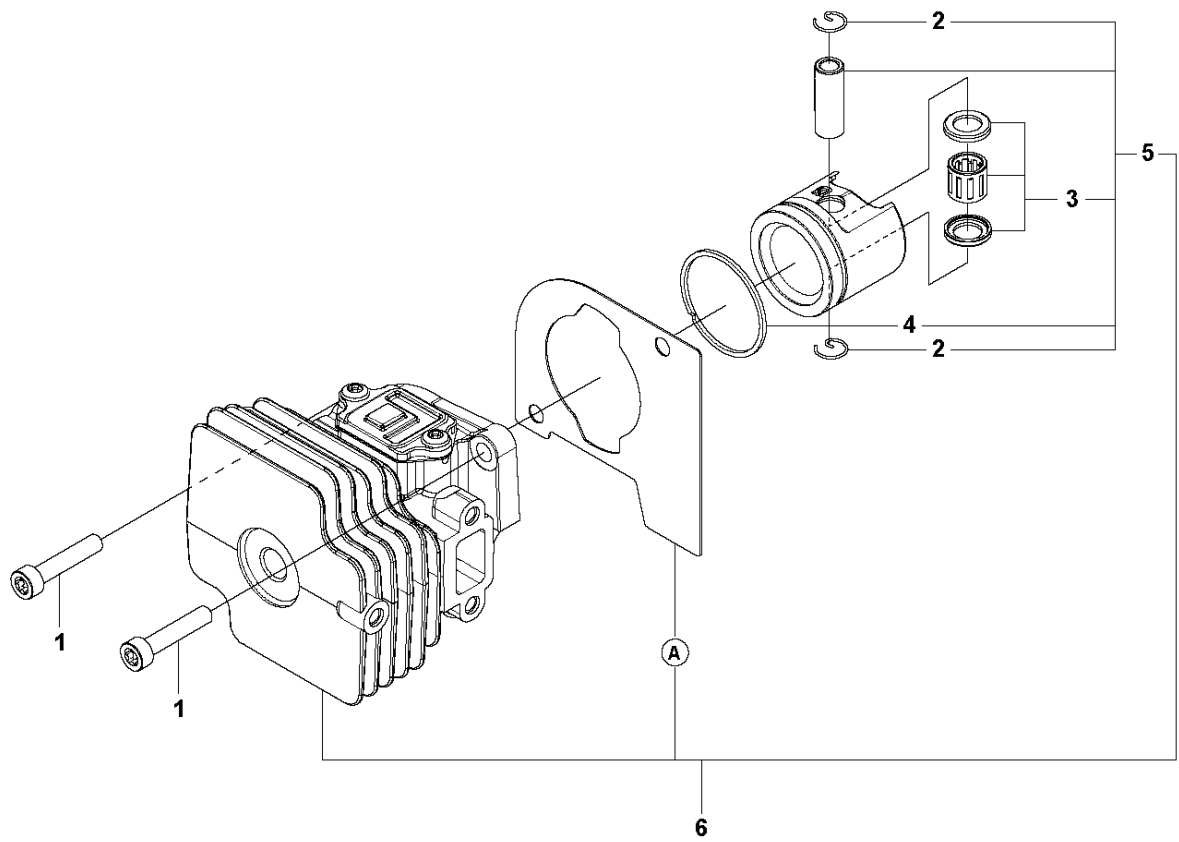

CYLINDER PISTON

CHTZ600

Ref	Part No	Description	Remark	QTY	KIT
1	525 82 50-01	SCREW ITXSCM		2	
2	737 44 08-00	CIRCLIP		2	5, 6
3	597 29 22-01	BEARING KIT		1	5, 6
4	505 15 58-02	PISTON RING		1	5, 6
5	510 22 36-04	PISTON ASSY		1	6
6	597 02 44-01	CYLINDER ASSY		1	
7	597 02 10-01	GASKET KIT		1	

**H** CHTZ600  
CRANKCASE

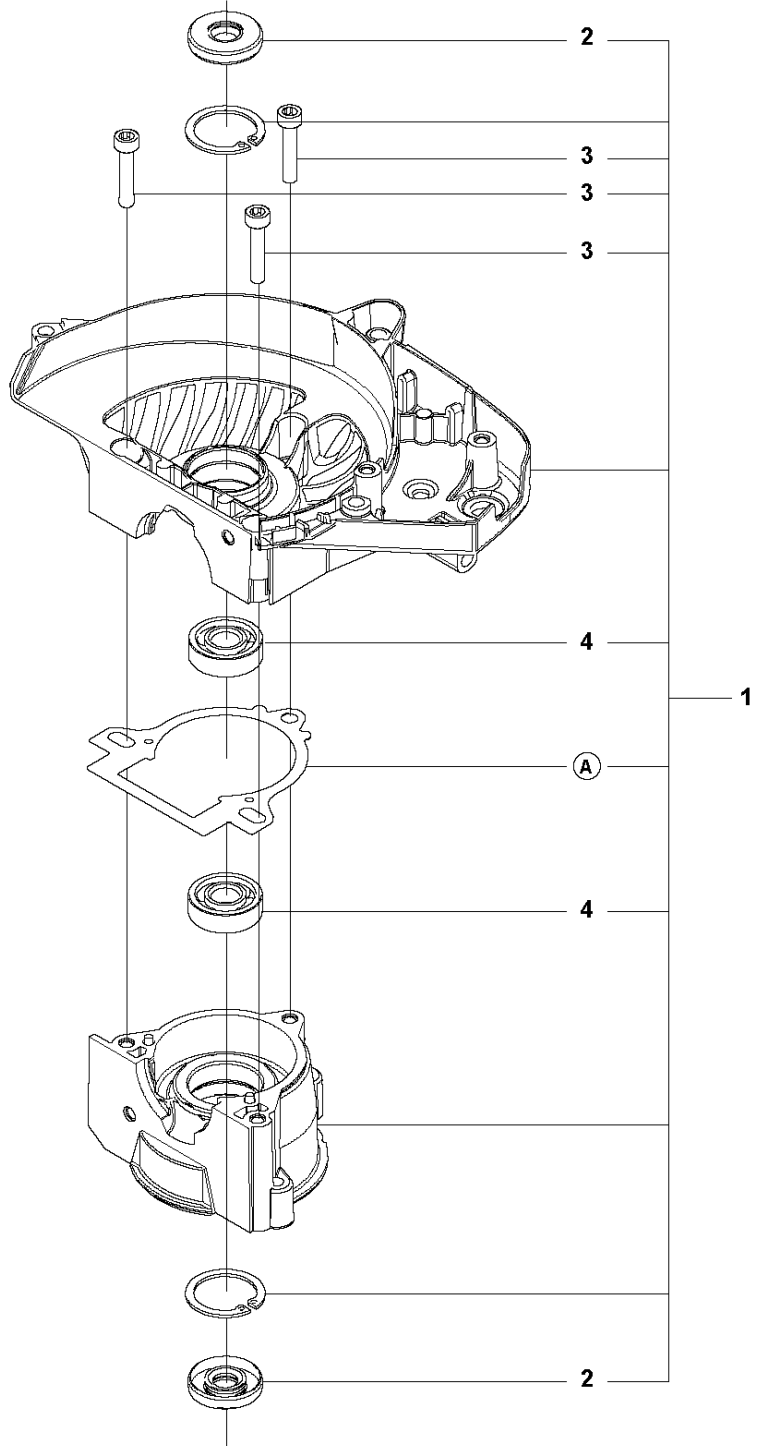

5

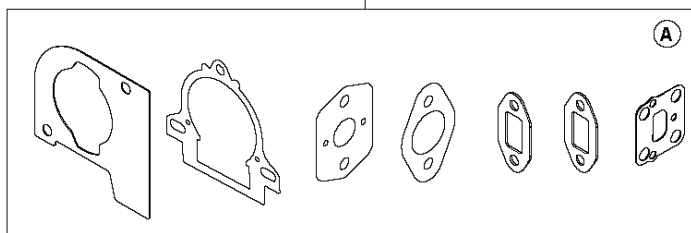



CRANKCASE

CHTZ600

Ref	Part No	Description	Remark	QTY	KIT
1	597 02 36-01	CRANKCASE ASSY		1	
2	525 63 73-01	SEALING RING		2	1
3	525 82 50-01	SCREW ITXSCM		3	1
4	525 72 84-01	BALL BEARING		2	1
5	597 02 10-01	GASKET KIT		1	

**CHTZ600  
CRANK SHAFT**

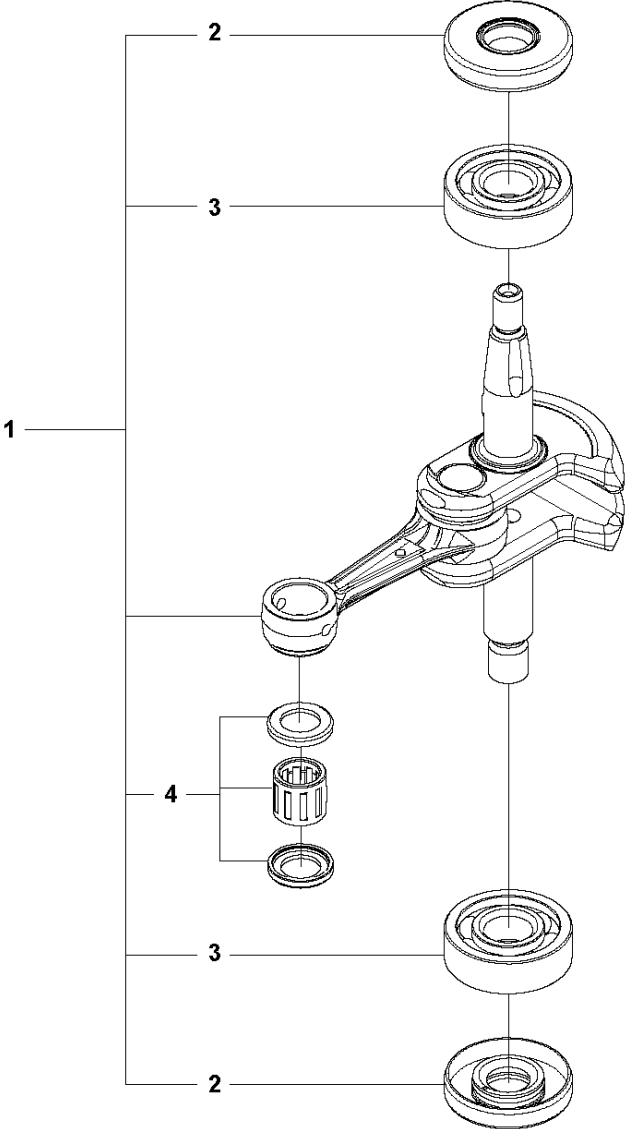

CRANKSHAFT

CHTZ600

Ref	Part No	Description	Remark	QTY	KIT
1	577 67 00-02	CRANKSHAFT KIT		1	
2	525 63 73-01	SEALING RING		2	1
3	525 72 84-01	BALL BEARING		2	1
4	597 29 22-01	BEARING KIT		1	1

**J** CHTZ600  
HANDLE

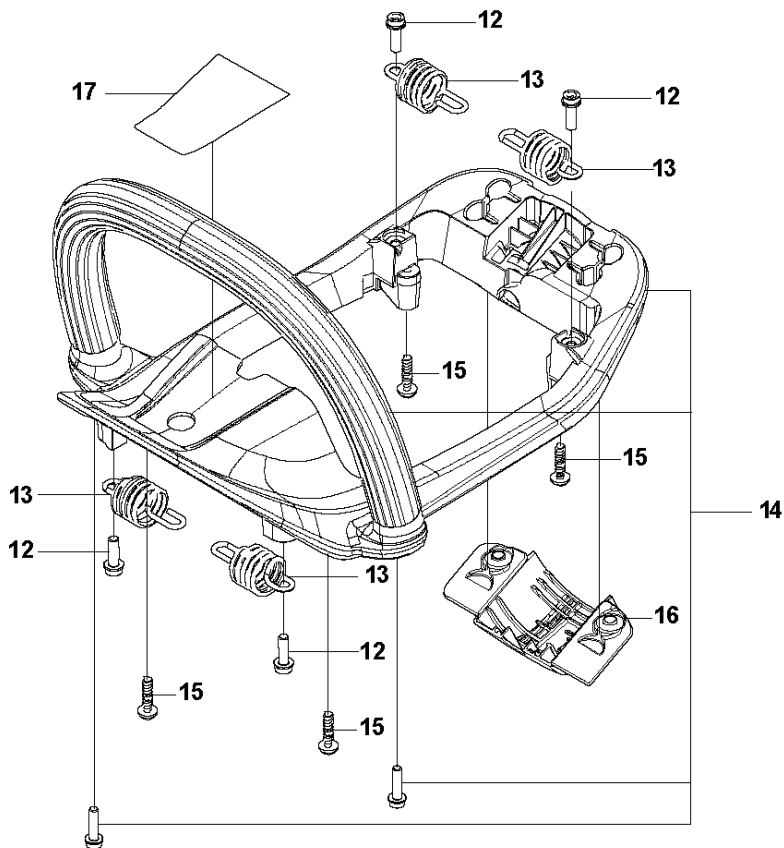
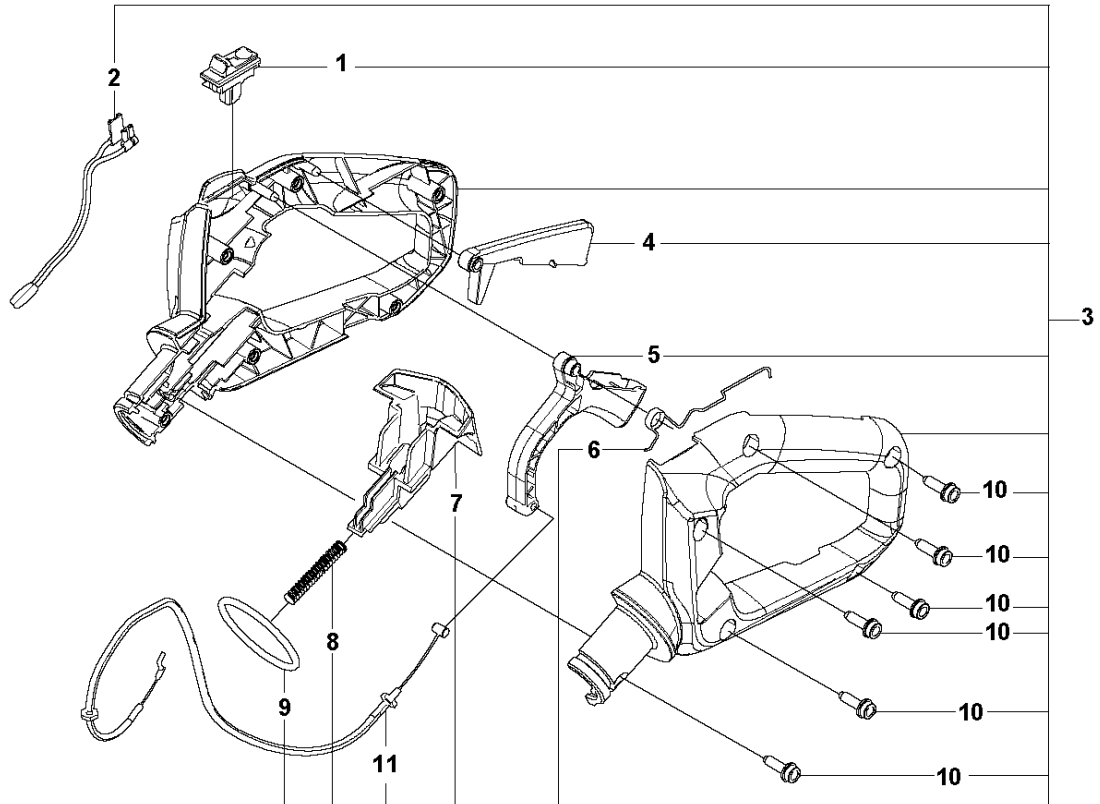

## HANDLE &amp; CONTROLS

CHTZ600

Ref	Part No	Description	Remark	QTY	KIT
1	537 41 90-01	SWITCH		1	3
2	574 48 88-06	SHORT CIRCUIT CABLE		1	3
3	597 02 40-02	REAR HANDLE		1	
4	580 27 68-02	THROTTLE LOCKOUT		1	3
5	590 05 76-02	THROTTLE CONTROL		1	3
6	590 68 66-01	SPRING		1	3
7	590 05 77-02	LOCKING BUTTON		1	3
8	504 08 98-02	RECOIL SPRING		1	3
9	575 23 20-02	O-RING		1	3
10	573 92 58-01	SCREW ITXSCFT		6	3
11	575 57 21-02	THROTTLE CABLE ASSY		1	3
12	525 75 51-01	SCREW ITXSCFM		4	
13	590 64 77-01	SPRING		4	
14	597 02 41-02	FRONT HANDLE ASSY		1	
15	521 51 81-01	SCREW		4	
16	591 15 69-02	PROTECTION		1	
17	593 88 91-02	LABEL		1	

**K** CHTZ600  
CLUTCH & GEARBOX

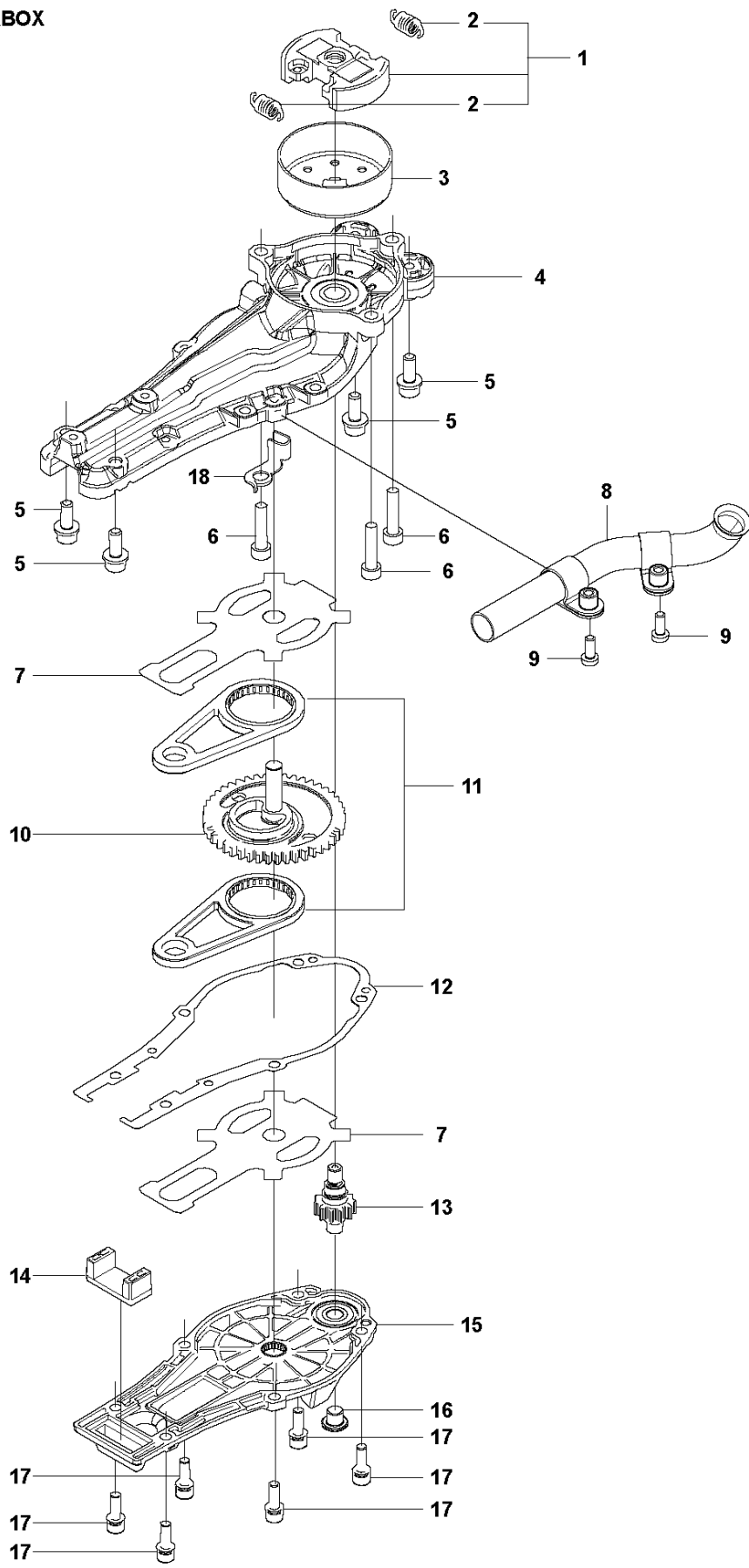

## GEAR HOUSING

CHTZ600

Ref	Part No	Description	Remark	QTY	KIT
1	582 19 31-01	CLUTCH ASSY		1	
2	590 81 96-01	CLUTCH SPRING		2	1
3	590 53 64-02	CLUTCH DRUM		1	
4	597 37 17-01	GEAR HOUSING ASSY		1	
5	576 59 08-01	BOLT		4	
6	544 21 84-03	SCREW ITXSCM		3	
7	590 53 69-01	PLATE		2	
8	591 04 69-01	EXHAUST PIPE ASSY		1	
9	525 75 51-01	SCREW ITXSCFM		2	
10	593 65 15-01	GEAR		1	
11	597 02 17-01	ROD		1	
12	590 53 77-01	GASKET		1	
13	590 53 67-01	GEAR		1	
14	590 53 71-01	SEALING		1	
15	597 37 18-01	GEAR HOUSING ASSY		1	
16	590 64 94-01	SCREW PLUG		1	
17	575 70 10-01	SCREW		6	
18	593 82 11-01	WIRE HOLDER		1	

**L** CHTZ600  
CUTTING EQUIPMENT

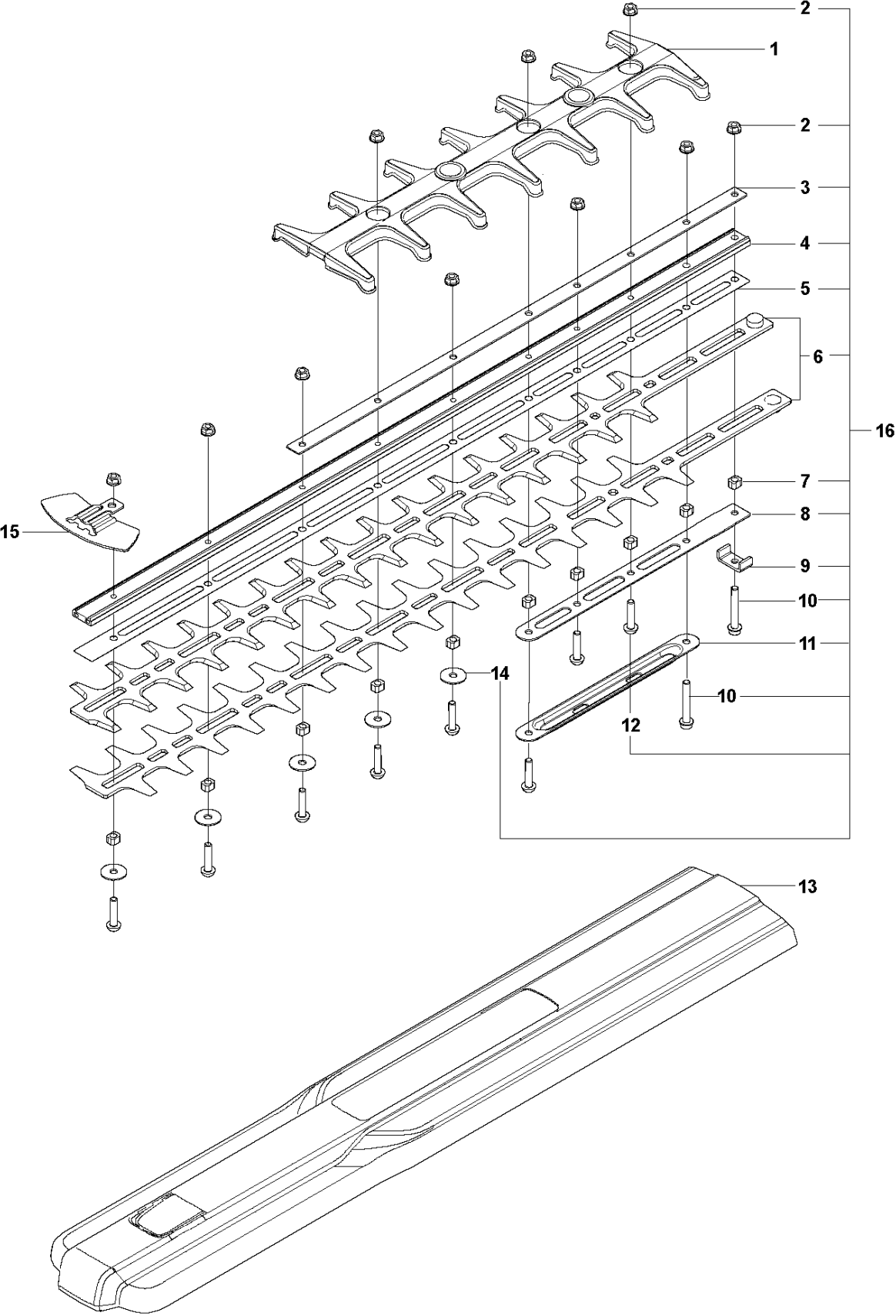



## CUTTING EQUIPMENT

CHTZ600

Ref	Part No	Description	Remark	QTY	KIT
1	598 77 60-02	PROTECTOR BAR		1	
2	592 75 13-01	NUT		10	16
3	592 84 87-01	BAR PLATE		1	16
4	590 32 71-01	GUIDE BAR		1	16
5	590 32 75-01	WEAR PLATE		1	16
6	597 02 18-01	BLADE KIT		1	16
7	592 65 43-01	SPACER		10	16
8	590 32 82-01	BAR PLATE		1	16
9	590 33 93-01	BRACKET		1	16
10	525 75 51-09	SCREW ITXSCFM		2	16
11	592 88 94-01	BAR PLATE		1	16
12	592 73 25-01	SCREW		8	16
13	590 65 14-02	TRANSPORT GUARD		1	
14	592 73 81-01	WASHER		5	16
15	590 71 26-01	PROTECTION		1	
16	597 25 43-01	CUTTING DECK KIT		1	

**M** CHTZ600  
ACCESSORIES

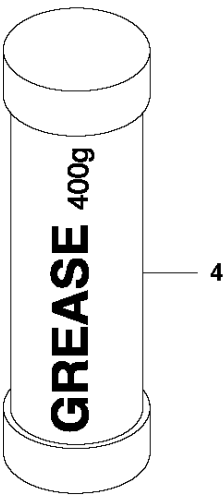
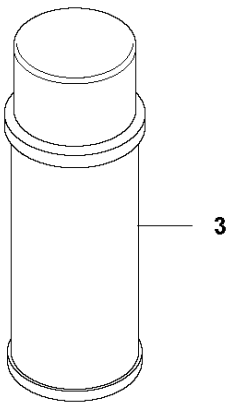
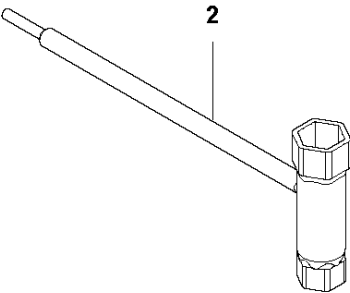
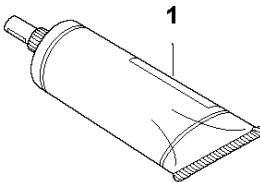

## ACCESSORIES

CHTZ600

Ref	Part No	Description	Remark	QTY KIT
1	587 29 99-01	GREASE		1
2	575 73 82-01	COMBINATION WRENCH		1
3	544 14 21-01	GREASE	UL21	1
4	588 81 48-01	GREASE		1